

THE USE OF PHOTOVOLTAIC CONCENTRATORS  
AS APPLIED TO TRACKING SOLAR COOLING SYSTEM.

M.G. Osman<sup>\*</sup>

College of Engineering, El-Mansoura University, El-Mansoura  
Egypt.

ABSTRACT:  
-----

At favourable conditions, the average intensity of solar power is about  $0.8 \text{ KW/m}^2$  at noon for a clear summer day in Kuwait. Assuming a photovoltaic system total efficiency to be 6%, the corresponding specific area required during this favourable atmospheric conditions will be about  $20 \text{ m}^2/\text{KW}$ ; which has to be increased considerably for the rest time of the day and year, unless a tracking solar system is used to limit to some extent the increase of this specific solar area.

In order to obtain a further decrease of such a specific solar area, conical concentrators are suggested to be used with the photovoltaic cells in addition to the tracking solar system.

In this paper a comparison between the experimental voltage-current characteristics of one type of photovoltaic cells with and without concentrators is presented; illustrating the design and shape of these concentrators when used with photovoltaic cells as applied to a solar cooling system in arid zones.

INTRODUCTION:  
-----

In considering solar energy converters for electrical and thermal energy supply to different terrestrial applications, concentration techniques appear advantageous.  $80 \text{ m}^2$  of line concentrator collectors were tested to cool demonstration solar house in Kuwait. Concentration supplied the cooling system with higher working temperatures, than flat plate collectors, leading to higher chiller coefficient of performance, less collector area and chiller capacity. For stand alone systems, electricity is also required to drive the tracking motor and the different pumps. Solar cells can be used to generate electricity from solar energy but the price is still very expensive. To achieve price reductions that can reach fraction of present day prices of bare solar cell systems, photo voltaic concentrators are considered.

---

\* On Sabbatical Leave To Solar Energy Department, Kuwait Institute for Scientific Research Safat, Kuwait.

As the solar intensity is increased, the generated current in the solar cell increase proportionally. The power losses due to internal series resistance increases at the square of the generated current. Therefore it is important to reduce these internal series resistance for concentrated solar energy conversion applications.

One of most important factors to be considered in designing a solar cell for use in concentrated sunlight is the internal series resistance of the cell. Wolf and Rauschenbach(1) have shown that the series resistance is made up of many components; the major contributors being bulk semiconductor resistance, the resistance of the diffused layer sheet, and the metal-to-semiconductor contact resistance. For these applications, it would be normal to use semiconductor material having low base resistivity, and to use the best state of the art contacting techniques. No further immediate gains in these two areas could be contemplated. On the other hand, there is some control over the resistance of the diffused layer sheet, which can be decreased and adjusted to an optimum value by increasing the depth of the diffused layer, and by placing an array of metallic grid lines over the cell surface. The optimum number of grid lines depends on the cell geometry and the sunlight intensity in which the cell is to be operated(2).

Another major consideration in the use of concentration methods in conjunction with solar cells is the heat generated as a result of the absorbed light not converted to useful electrical energy. As concentration ratios increase, the absorbed energy also increases, causing the cell temperature to rise. This increase in temperature results in a decrease in the cell conversion efficiency. Forced-air or water-cooling equipment could be used to offset this temperature rise; however, such equipment is costly, complicated, and would consume power, so there still would be a loss factor to be considered. No additional power would be required for free convective cooling, but in this case there would be a useful limit of concentration ratio beyond which there would be no gain.

Considering the above factors, a simple concentration method was evaluated. This system, incorporating a conical-reflector along with a round solar cell appears to be economically advantageous.

Theoretical Analysis:

In choosing the proper concentrator design for a solar-cell system one must first decide whether a high concentration ratio can be utilized or whether one is restricted to low concentration ratios. If the system is to be operated without any external cooling then the concentration ratios are essentially limited to less than five to avoid reductions of cell performance due to cell heating. Higher concentration ratios can be advantageous only if external cooling is available or if some of the generated power can be diverted for this purpose. This study was restricted to low-concentration systems not requiring any such external thermal sinks.

An inexpensive and simple concentrator system was desired so a flat-plate collector or a conical collector were the logical choices for this elemental concentration system. Because the conical system had a wider range of concentration ratio available, it was decided to investigate this system further. One of the advantages of this configuration was that a simple conical concentrator could be easily and inexpensively manufactured from polished sheet metal. Also this type system formed easily and the design itself made a structurally stable shape not easily damaged or distorted by adverse weather conditions, handling etc.

Although the conical concentrator system does not provide uniform intensity throughout the cell area it does have reasonably good distribution of light over the target area, so that localized hot spots are minimized. Also inexpensive concentrators are not perfectly formed thus causing distortions and essentially minimizing the hot spots from the concentration that would be expected from a perfect conical design. The flatplate concentrator would be better because it can provide uniform intensity over the complete cell area.

To evaluate the conical design on a theoretical basis a calculation was made of the concentration ratio that would be obtained as the opening angle of the conical reflector is varied. The angle of the cone and the length of the side of the cone was adjusted so that light striking the top uppermost portion of the conical collector was always impinging upon the cell surface area. This eliminated double reflections and restricted the length of the concentrator to a finite value. The diagram of the concentrator system is shown in Fig. (1). The theoretical concentration ratio was determined by calculating the circular area corresponding to the top of the cone, that is the area intercepting sunlight, and dividing by the area of the target or cell surface. A round solar cell of 4.5 cm diameter was used in this study.

Assuming a mirror sun light reflection and considering the case where the sun light is perpendicular to the photovoltaic cell surface as shown in Fig. 1, the length "L" of the conical concentrator side will vary as a function of the cone angle  $\phi$  according to equation (1):

$$L = 2 (D \tan (90^\circ - \phi)) \cos \phi/2 \quad \dots(1)$$

where D is the diameter of the photovoltaic cell.

Table 1 gives the values of L against  $\phi$  for D = 4.5cm. This relation is shown in Fig.(1) curve labeled "L" together with the corresponding concentration ratios  $R_1$  &  $R_2$  assuming 100% & 50% reflection factors for the concentrator respectively.

Table 1

$\phi^\circ$	20°	30°	40°	50°
L cm.	24.34	15.04	10.07	6.844

Using a 100 percent reflection factor from the concentrator surface one obtains the uppermost curve of Fig. (1) labeled R. By using a 50 percent reflection factor the lower curve is obtained. Starting at an angle of 90 deg the light reflected from the reflector does not strike the cell and a concentration ratio of 1 would be obtained.

Small concentrations ratios can be obtained with very short conical reflectors. As the maximum limit of 9 is approached the length increases rapidly. For practical systems concentration ratios above 6 or 7 would be unduly long. For this study it was decided to choose a cone angle of about 45 deg. Thus giving the possibility of a concentration ratio of about 5 with 100-percent reflectivity or about 3 with a 50- percent reflectivity. It was expected that a reflectivity of 50-percent would be economically feasible and would give sufficient information on the heating effect and equilibrium temperature obtainable from this type of concentrator. From a cost standpoint the concentration ratio of 3 would give the equivalent of the output of three solar cells for the cost of one cell plus the concentrator. A model concentrator system using this design was built and the performance evaluated.

#### Experimental Work & Results:

For the solar intensity range in Kuwait, the optimum grid spacing for use in concentrated sunlight from a conical reflector with a concentration ratio of three to five

was theoretically shown in previous investigations to be about 0.2 cm for P+/N type cells.<sup>(3)</sup> Polyvariable experiments verified that this grid spacing provided optimum performance at solar intensities of about 300 mw/cm<sup>2</sup> (3, 4). For the solar intensity range in Kuwait that the typical space-type silicon cell junction depth of about 0.5 micron, resulted in a cell spectral response that was also well optimized for use in a solar spectrum on the earth's surface.

With the use of a comb-like grid pattern, cells of almost any geometrical shape can be designed for low series resistance and optimum performance at higher than normal intensities. Because the single crystalline silicon ingots from which solar cells are made are circular in cross-section, it is more costly because of the cutting wastes and poor utilization, to cut these ingots into rectangular shapes. Therefore, to obtain a more economical cell design, a round cell (determined by the diameter of the silicon ingot) with the optimum grid configuration was utilized in this study. A 4.5-cm diameter round cell and comb grid configuration were used.

Several conical metal concentrators were made from thin slightly polished stainless steel sheets. To achieve an inexpensive concentrator polished aluminum or a formed plastic cone with an aluminized surface would probably be a better choice of material where large numbers of concentrators are required. These concentrators were made with the opening angle being 45 deg, which, according to Fig.(1), would result in a concentration ratio of about 3 with a 50 percent reflectance factor. The opening at the bottom of the cone was made 4.5 cm in diameter, the same as the cell diameter, and the length of the concentrator was made 6.9 cm long in accordance with the value in Fig.(1). The solar cell was a P+/N type cell designed to operate with little or no loss in efficiency at concentration ratios of about 3 to 1. This was accomplished by decreasing the spacing between grid lines to 1.5 mm compared to normal spacing 4.0 mm for cells operating at one sun illumination.

Since this concentrator system was expected to operate with no additional cooling system other than free convection, a test was made to determine the equilibrium operating temperatures expected.

A thermocouple was attached to the solar strip contact on top of the solar cell and the equilibrium temperatures were measured. On a day without wind and with the solar cell and concentrator shadowed, the cell temperature and ambient temperature was 30 deg C. The temperature increased to 50 deg C with about 98 mw per cm<sup>2</sup> of sunlight on the cell without the concentrator. With the con-

## E.19. M.G. Osman.

concentrator in place and at a concentration ratio of 2.6, the temperature increased to 65 deg C. On another day with about a 15 mph wind, the ambient was about 29 deg C, the cell without concentrator reached 31 deg C, and with concentrator reached 51 deg C.

The voltage output of a solar cell decreases with an increase in temperature. This effect can be approximated by shifting the voltage axis of the voltage current characteristic curve by the temperature coefficient which for the type of cell used here is 2.0 mv per deg C. In the two cases mentioned this would result in a significant but not a prohibitive power loss. Also the first case would probably be about the most severe heating problem most localities would experience as an average weather conditions.

To further evaluate this concentrator system the voltage current characteristic curve of a solar cell was measured with and without the concentrator. The results were obtained in sunlight by measuring the generated current and voltage while varying the load across the solar cell terminals. The characteristics obtained are given in Fig.(2). Curve A shows the generated I.V curve of the cell as equilibrium temperature without any concentrator. Curve B shows the I.V. curve immediately after placing the concentrator in place and before the temperature could change appreciably. Curve C shows the I.V curve obtained with the concentrator and after attaining temperature equilibrium.

At maximum power the concentrator system generated 1.06 amps at 0.48 volt, or 0.508 watt. An intensity ratio of about 2.6 was obtained, which resulted in an increase in the power output from 196 mw to 508 mw at equilibrium temperature conditions, or a power ratio of 2.6. Because the power ratio was equal to the ratio of the increase in the sunlight intensity, there was no net loss due to heat build-up and the increased intensity, indicating that the cells were well designed to operate efficiently at this light intensity. This was further demonstrated by the cell efficiency values of 10.9 percent without concentrator and 10.8 percent with concentrator. The losses due to heating were 26 mw as can be seen by comparing the power output from curves B and C, but these losses were balanced by gains in efficiency at the increased intensity. By connecting several concentrator systems such as this together in parallel or series, a modular power supply can conveniently be put together on a simple supporting structure. Many modular systems could conveniently be mounted on a tracking platform to build up a complete power system.

### Effect of Orientation:

Use of concentrators does require some sort of tracking to obtain maximum performance. The effects of orientation with respect to the sun was checked for this system and the data compared to bare cells without a concentrator in Fig.(3). For a bare cell in uncollimated sunlight, and with no effect made to avoid edge lighting, the short-circuit current essentially follows a normal sine function with respect to sunlight angle of incidence above an angle of about 10 deg. The deviation at low angles was due to sky background, scatter radiation and cell edge lighting, generating a small current. The cell with concentrator in place had a much greater sensitivity to angle of incidence. The output fell off to a negligible output at angles less than 45 deg. Again a back-ground of scatter radiation maintained the cell output above zero. Also the output of the concentrator system reached the same output as that of the bare cell at about 60 to 65 deg angle of incidence. Therefore, to realize maximum performance using this concentrator system sun orientation to within about 10 deg of normal incidence would be necessary.

### Solar Cell Spectral Response:

The spectral composition of a given irradiance is important to photovoltaic measurements because the conversion efficiency of photovoltaic materials is strongly dependent on the wave length of the irradiance. Fig.(4) illustrate the relative spectral response of a silicon solar cell together with two common solar irradiance spectrum. Photovoltaic spectral response curve is used to quantify cell electrical performance but does not provide estimation of typical terrestrial sunlight performance which is required when comparing the performance of devices with dissimilar spectral responses.

To meet this need an alternative approach is widely used based on reporting photovoltaic output for a particular terrestrial sunlight reference and spectrum. With this approach the spectral response of the device is replaced by a single performance quotation of electrical output for the reference irradiance conditions.

At present the most widely used reference condition for terrestrial applications is a total irradiance level of  $100 \text{ mw cm}^{-2}$  and the Air Mass 1.5 spectrum shown in Fig.(4).

Implementation of this approach is due to practical problems due to performance measurements are made under simulated sunlight or outdoor sun light conditions which differ in level and spectral content from the reference conditions.

## E.21. M.G. Osman.

### Solar Concentrating Tracking Thermal System:

Electricity generated from the conical concentrating photovoltaic system was used to drive the micro motor of 80 m<sup>2</sup> array of cylindrical parabolic line concentrating (C.R, 8:1) system to heat water to supply an absorption chiller with the required thermal energy to produce cooling effect for solar house in Kuwait.

The array has 160 parabolic troughs mounted on a north-south orientation at an angle 15° from the horizontal. The tracking system allows the trough to be oriented from east to west according to actual sun position. The absorber tube is 8 mm tube and is covered with black chrom selective coating ( $\alpha = 0.95$ ,  $\epsilon = 0.15$ ) solar radiation (direct) is reflected by the parabolic trough onto the copper tube of each trough Fig.(5).

### Performance Analysis of the Line Concentrating Collectors:

As the collectors are of the concentrating type, they make use only of the direct radiation part of solar insolation, shows the efficiency of the collector system. Analysing the energy flow chart, we deduce the estimation for energy loss via glass surface area (10%), mirror surface area (19%), reflection (7%) and both convection radiation (13%), and this gives an average utilisable energy of about (55%) for a radiation intensity of 0.8 Kw/m<sup>2</sup>. Figure 6 shows the collectors, energy flow chart and their efficiency with respect to radiation intensity and time of day.

### CONCLUSION:

By using a simple conical solar-concentrator system to obtain about three times the output from each solar cell, costs of solar cell power systems can be reduced by more than a factor of five.

A concentrator system has been described that will operate at a reasonably low temperature without any auxiliary cooling equipment. The solar cells were designed so that the slightly elevated temperature and at the increased sunlight intensity, there was no decrease in efficiency. Therefore the net power output from the system was increased by a factor of about three over that expected from an unconcentrated solar cell system.



REFERENCES:  
-----

1. Wolf and Rauschenbach, "Series Resistance Effects on Solar Cell Measurements", Advanced Energy Conversion, 9, Pergamon Press, 1963.
2. Wolf, "Limitations and Possibilities for Improvement of Photovoltaic Solar Energy Converters, Considerations for Earth's Surface Operation", Proc. IRE, 48, pp. 1246-1263; July, 1960.
3. E.L. Ralph and P. Berman, "Silicon Cells for use in Concentrated Solar Energy", 17th, Annual Proceedings Power Sources Conference, May 1963, pp. 1-4.
4. P. Berman and E.L. Ralph, "Improved Solar Cells for use in Concentrated Sunlight", 18th, Annual Proceedings Power Source Conference, May 1964, pp. 159-163.
5. Schimmel, W.P. 1973. An analysis of linear focused collectors for solar power IECEC, Sandia Laboratories Report SLA - 73 - 5318A, USA.
- 6 . M.G. Osman, 1985. Performance Analysis and Loadmatching For Tracking Cylindrical Parabolic Collectors For Solar Cooling in Arid Zones. Energy Conversion and Management, U.S.A. Vol. 25, No. 3.

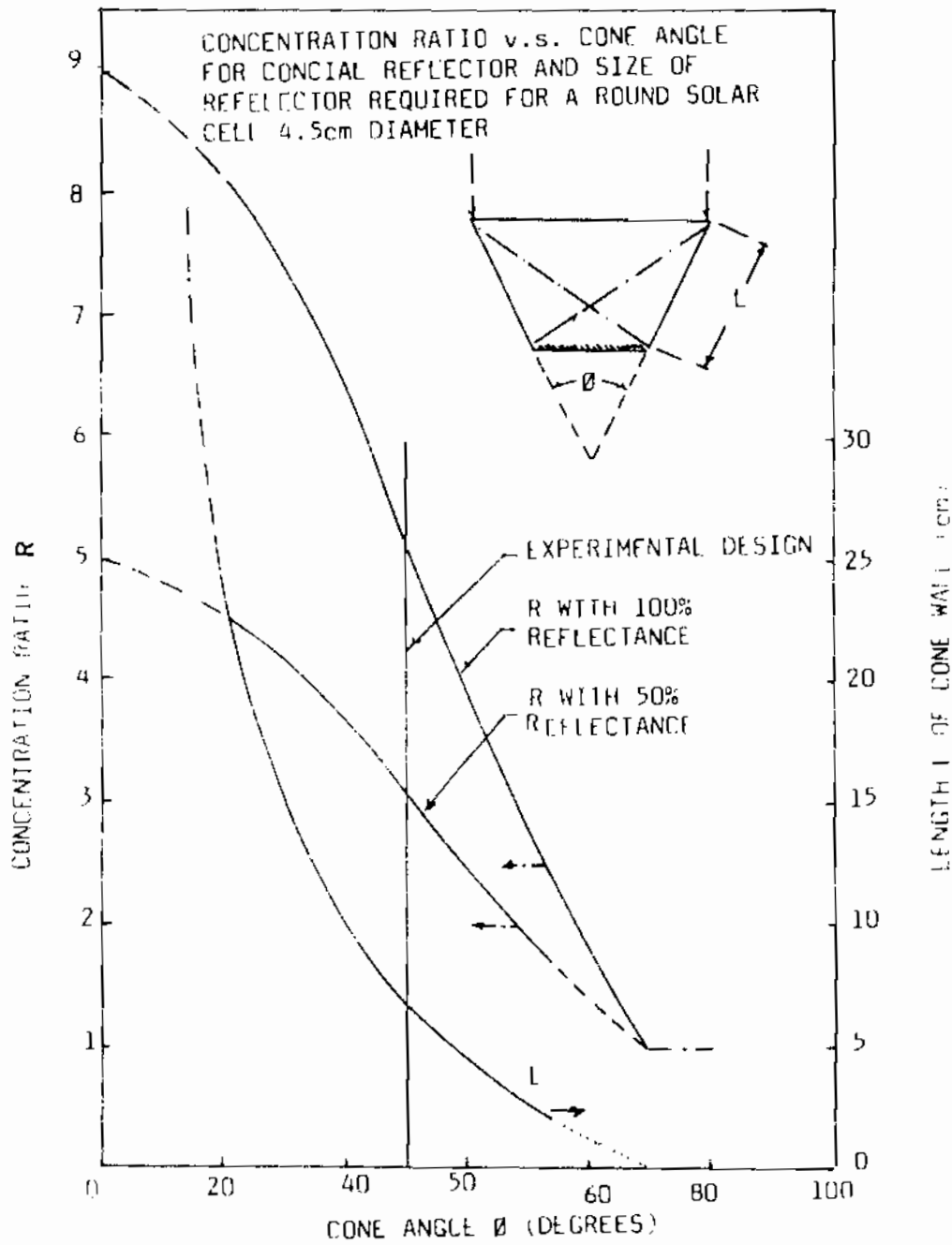
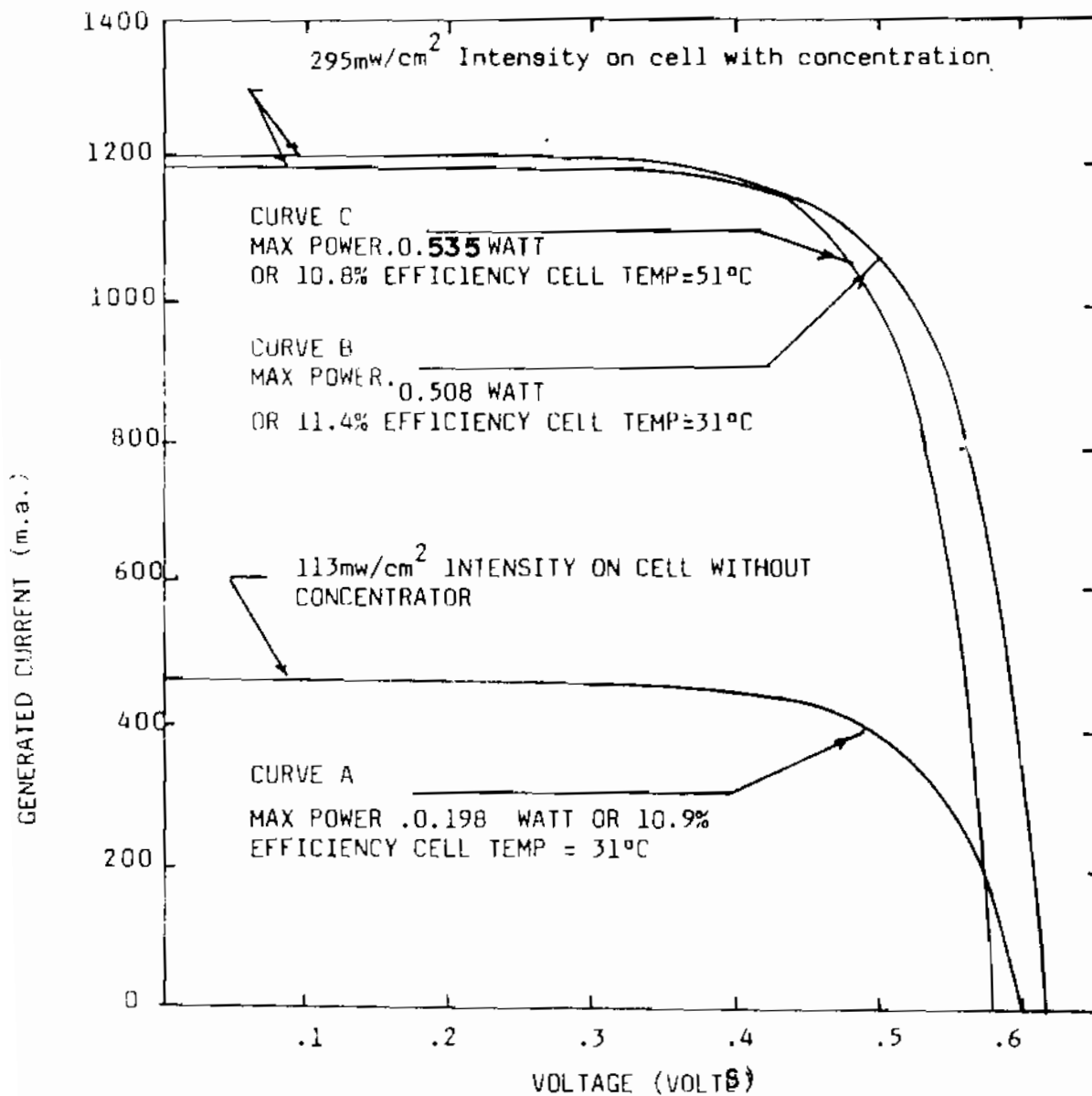

Fig. (11): Diagram of conical concentrator system. Theoretical values of concentration ratio and length of concentrator are plotted versus opening angle of cone.



Fig(2) Voltage current characteristic curves obtained in sunlight for: A-BarE solar cell at equilibrium temperature; B-Solar cell with concentrator before temperature changed; C-Solar cell with concentrator after attaining temperature equilibrium.

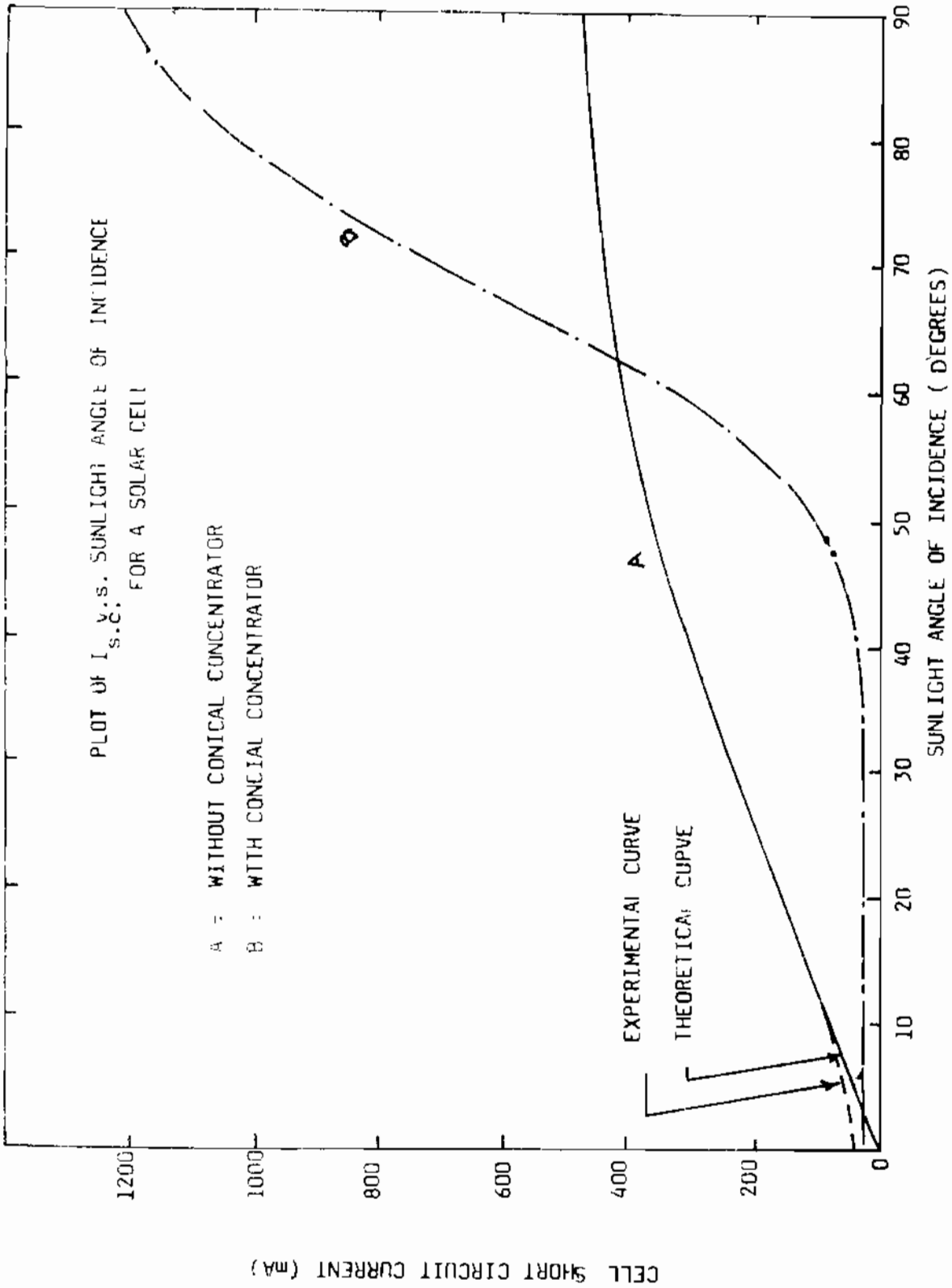

Fig. 3 : Effect of sunangle of incidence on output from plane solar cell and conical concentrator system.

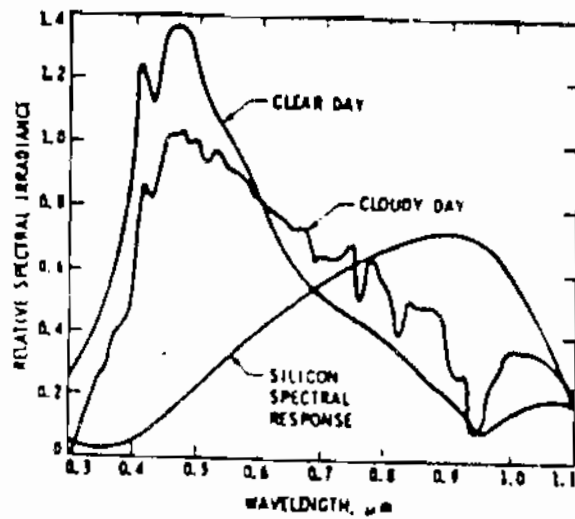
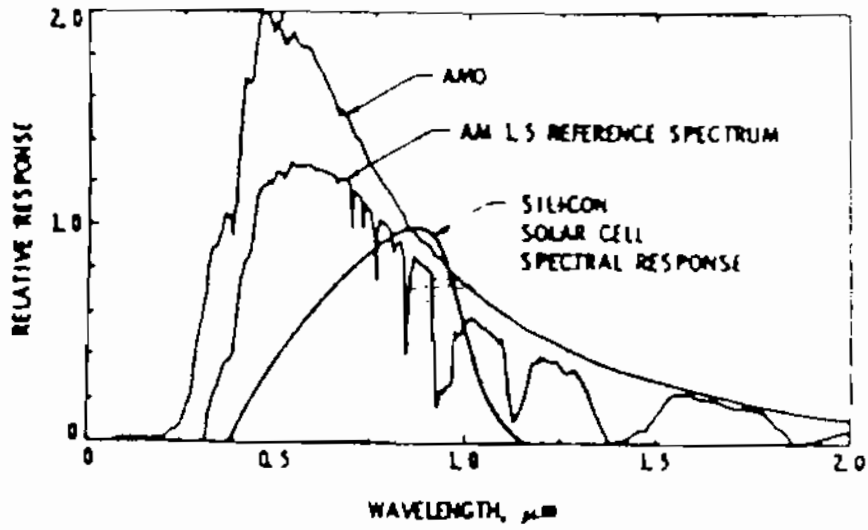

Fig.(4): Typical solar cell spectral response versus solar irradiance spectra.

E.27. M.G. Osman

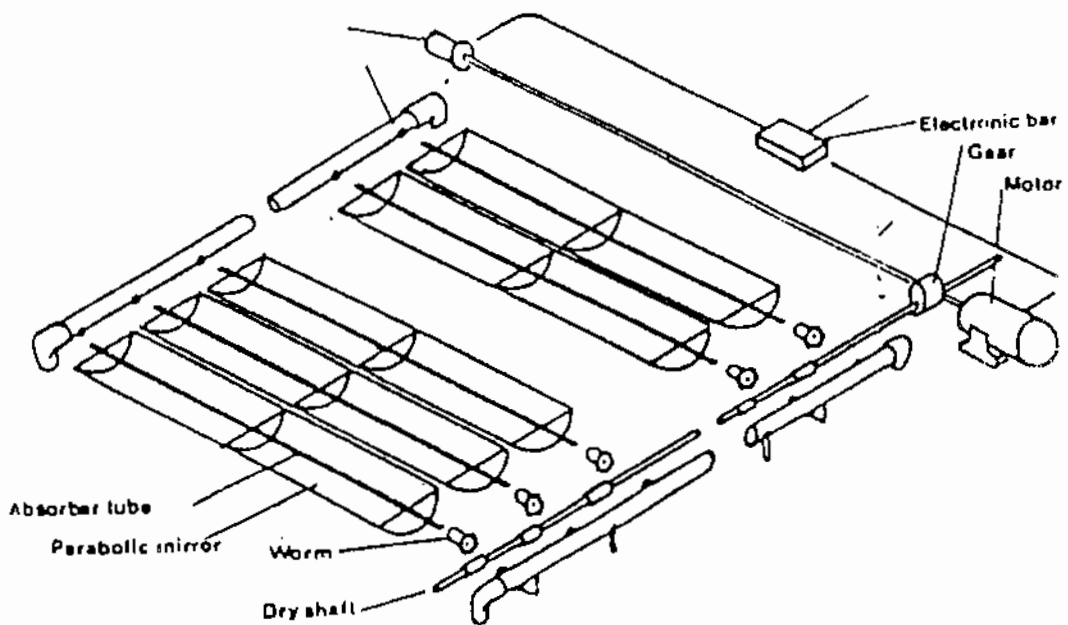
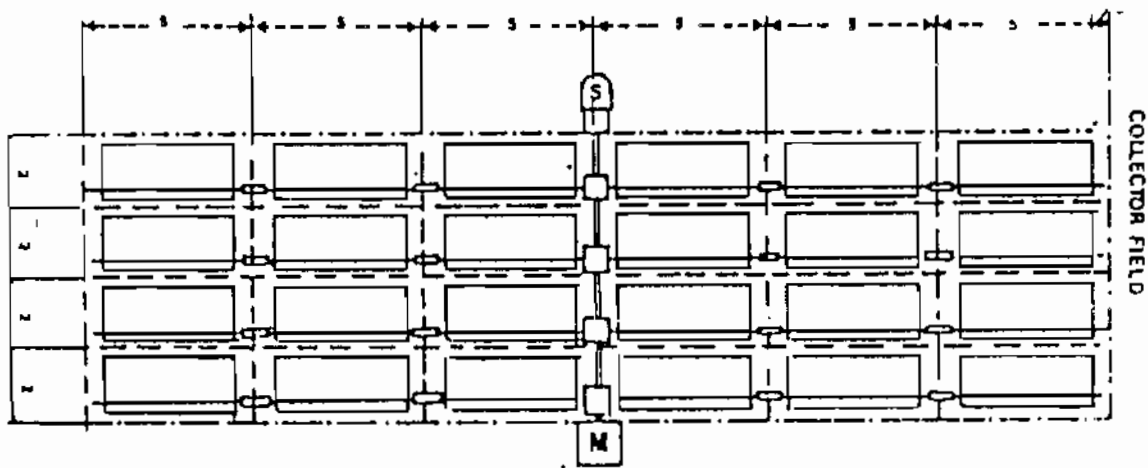
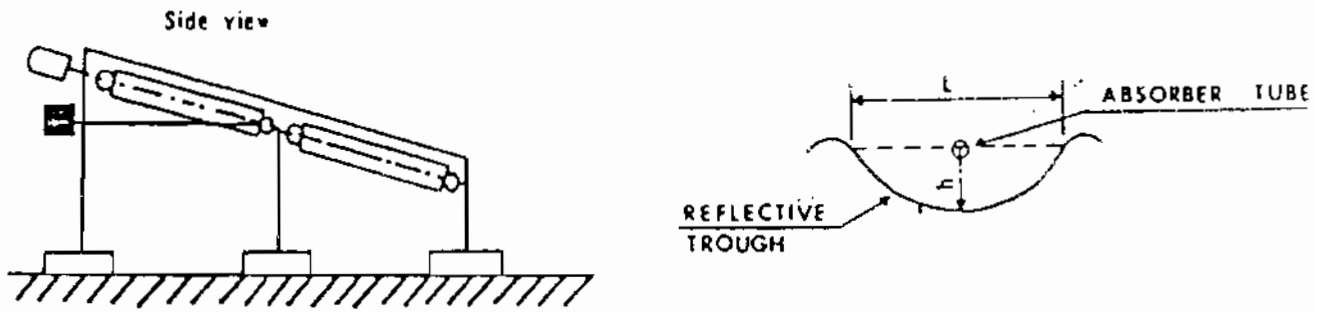

Fig.(5): Details of the line concentrator collector system.

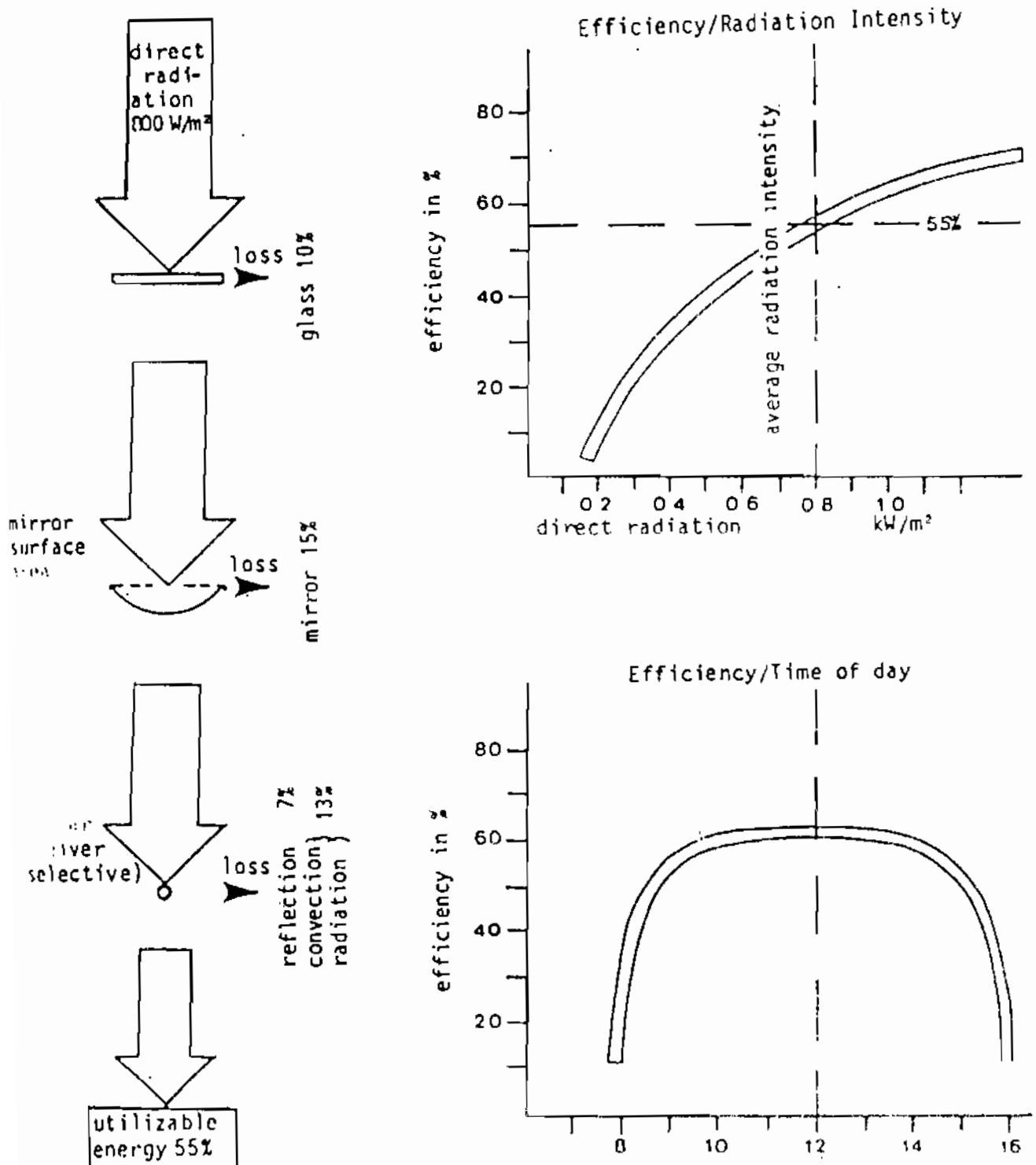

Fig. (6): Energy flow chart and efficiency with respect to radiation intensity and time of the day in Suleibiya Demonstration Solar House.