

Natural Convection Heat Transfer from Arrays of Different Fin Geometry

انتقال الحرارة بالحمل الحر من مصفوفات ذات زعانف مختلفة الشكل

E.A.M. Elshafei and E.A. El-Negiry

Mechanical Power Eng. Dept.,

Mansoura University., Mansoura, Egypt

eelshafei@mans.edu.eg, Emad-elngiry@yahoo.com

ملخص البحث

يهدف البحث إلى إجراء دراسة معملية لانتقال الحرارة بالحمل الحر من مصفوفات ذات زعانف رأسية بأشكال مختلفة تحسب نفس العدد من الزعانف المتساوية السمك والارتفاع وكذلك مساحة القاعدة، بينما يتغير الفرق بين درجتي حرارة قاعدة المصفوفة والهواء الجوى المحيط بواسطة التحكم في معدل الطاقة الكهربائية اللازمة لتسخين قاعدة المصفوفة. أجريت التجارب لوضعين لقاعدة المصفوفات الرأسية والأفقية في مدى تغير لقيمة رقم رايلى بين 2×10^3 و 8×10^3 . وقد تبين من النتائج المعملية التأثير الكبير للفرق بين درجتي حرارة سطح قاعدة المصفوفة والهواء المحيط على معامل انتقال الحرارة المتوسط في كلا الوضعين بينما كان تأثير كلا من شكل الزعنف واتجاه قاعدة المصفوفة عليه محدودا. وبتحليل النتائج على مدى التغير في رقم رايلى لحالة الوضع الرأسى لقواعد المصفوفات، وجد أن معامل انتقال الحرارة المتوسط في حالة المصفوفة ذات الزعانف المستقيمة يزيد عنه في حالة المصفوفتان ذات الزعانف الغير متماثلة وذات الزعانف المموجة المتماثلة بمقدار 15% و 10% على التوالي وأن معدل الزيادة في ذلك المعامل للمصفوفة ذات الزعانف المستقيمة حوالى 10% عنه عندما تكون قاعدتها في وضع أفقى بينما يقل معدل الزيادة في معامل انتقال الحرارة المتوسط عندما تكون قاعدة المصفوفة رأسية في حالتي المصفوفتان ذات الزعانف الغير متماثلة والمموجة المتماثلة عنه في الوضع الأفقى للقاعدتين إلى حوالى 2%، 4% على التوالي. وقد أظهرت النتائج أيضا أن تأثير كلا من اتجاه قاعدة المصفوفة وشكل الزعنف يقل بزيادة قيمة رقم رايلى.

Abstract

Natural convection heat transfer from vertical fin arrays of different fin geometry is experimentally investigated. Number, thickness and height of fins are kept constant while base to ambient temperature difference is varied. Experiments are carried out for vertical and horizontal fin array base plate. The Rayleigh number is ranged from 2×10^3 to 8×10^3 . Results showed that the average heat transfer coefficient is greatly affected by the base-to-ambient temperature difference and less affected by the fin geometry and base plate orientation. Over the tested range of Rayleigh number, and with vertical base plate arrays, the straight fin array offered the highest heat transfer coefficient (by a factor of 15% and 10% more than that of unsymmetrical and symmetrical corrugated fin array respectively). An enhancement in the heat transfer coefficient by a factor of about 10% for the straight fin array more than that of horizontal base plate is also observed and that enhancement is reduced to about 4 and 2% for unsymmetrical and symmetrical corrugated fin array respectively. The effect of both orientation and fin geometry seems to be diminished with the increase of Rayleigh number.

Keywords: Convective heat transfer, Fin arrays, cooling of electronic equipment, Natural convection, Heat sinks.

Nomenclature

A_s	surface area, (m^2)	Ra	Rayleigh number, (Gr.Pr), $g\beta\Delta T S^3/\nu\alpha$
$F_{A\infty}$	shape factor	Ra*	modified Rayleigh number, dimensionless
Gr	Grashof number, $g\beta\Delta T S^3/\nu^2$	S	fin spacing, (m)
g	gravitational acceleration, (m/s^2)	T_f	film temperature, $T_f = (T_s + T_\infty)/2$, (K)
H_f	fin height, (m)	T_∞	temperature of ambient air, (K)
h_{av}	average convective heat transfer coefficient, (W/m^2K)	T_s	average surface temperature of fin array, (K)
k	thermal conductivity, (W/mK)	ΔT	temperature difference, ($T_s - T_\infty$), (K)
L	fin length, (m)	t_f	fin thickness, (m)
m	parameter, dimensionless	t_{bp}	base plate thickness, (m)
N_f	total number of fins	W	width of fin array = $t_f N_f + s(N_f - 1)$, (m)
Nu	Nusselt number, dimensionless		
p	fin perimeter, (m)		
Q	heat flow rate, (W)		

Greek Symbols

α	thermal diffusivity, (m^2/s)
β_∞	thermal expansion coefficient at T_∞ , ($1/K$)
ε	surface emissivity
η_f	fin efficiency
ν	kinematic viscosity, (m^2/s)
θ	corrugation angle

Subscripts

av	average
c	convection, cross section, channel
ec	end side channel
f	film, fin
in	input
L	loss
r	radiation
s	surface

Introduction

Natural convection heat transfer from fin arrays is one of the major concerns on cooling of electronic components and small energy conversion devices, despite the many applications of cooling by forced convection. The natural buoyancy of heated air allows designers to avoid active cooling, increasing reliability and decreasing costs.

The heat dissipated from a fin array by natural convection is mainly dependent on its surface area. So, more fins in the array means more heat

dissipation at a given temperature rise. The heat transfer coefficient depends not only on the temperature rise and surface area, but also on fin configuration and fin spacing. The open gap between fins can play an important role in heat transfer mechanism. It must be large enough to avoid boundary layer interference which resulted in a slow heat removal due to the needed higher pressure to move air away than natural convection can provide.

Chistopher (2002), Malhammar (2003) and Guvenc and Yuncu (2001) recommended values for fin spacing to be larger than 7mm. This is based on the direction of heated air traveling length in

respect to gravity. Elenbaas (1942) the first to investigate this behavior obtained an experimental correlation to predict the heat transfer coefficient for vertical rectangular fins under these conditions. Based on Elenbaas correlation, Simons (2001) presented a simple formula to predict natural convection heat transfer coefficient, and Christopher et al (2002) obtained correlations for the optimum fin spacing as a function of Rayleigh number.

Another correlation for the optimum fin spacing for fin arrays of vertical base and fins as a function of Rayleigh number using the vertical length L which is aligned with gravity as a characteristic length was reported by Cathy (2001). As reported by Elliott (2003), the distance between fins is dependent on the depth or height of the fins, deep finned arrays will need more space between adjacent fins than shallow ones unless fan cooling is used. The above conclusions were also reported by Simons (2002), who estimated natural convection heat transfer from arrays of vertical parallel flat plates. With fixed fin length and over a range of base-to-ambient temperature difference, it is reported that the optimum fin spacing was around 8 mm.

The effect of the channel aspect ratio, S/L , on the distribution of flow properties and on the local and average Nusselt numbers was investigated numerically by Hernandez et al (1993). They reported that the average Nu is found to be almost independent of the channel aspect ratio for the whole range of the modified Rayleigh number, Ra , except for low enough Grashof numbers in the case of single channel, and for large Grashof numbers in the case of multiple channel. They related that to the effect of the counter flow heat conduction

at the entrance of single channel and within a multiple one.

An investigation of natural convection heat transfer from arrays of isothermal triangle fins on a vertical base plate carried out by Karagiozis et al (1994). For several arrays geometry and over a large range of Rayleigh number, they reported that at intermediate Rayleigh number, the heat transfer coefficient for fins running vertically on a vertical base plate was up to 80% higher than for when the fins were horizontal. As the Rayleigh number increases, $Ra > 4 \times 10^4$, they found that the effect of fin geometry decreases and heat transfer coefficients for all arrays in vertical orientation are found very close to collapse onto a single curve.

The performance of fin arrays of vertical and horizontal heated bases was studied by Guvenc, and Yuncu (2001). The fin length and fin thickness were kept fixed while both fin height and spacing were varied as well as the base to ambient temperature difference. They reported that the fin spacing is the most effective parameter on the performance of fin arrays; and for every fin height, for a given base-to-ambient temperature difference, there exists an optimum value of the fin spacing for which the heat transfer rate from the fin array is maximized. For all tested fin arrays, Guvenc, and Yuncu (2001) also observed that the heat transfer enhancement with vertically oriented bases is greater than that with horizontally oriented ones.

Malhammar (2003) presented a new concept to assess the performance of heat sinks which is called "the volumetric efficiency for natural convection". It is reported that the temperature difference must be regarded as the most important parameter affecting the natural heat transfer coefficient. With increasing temperature difference, not only

increases the air velocity but also decreases the optimum fin spacing and therefore increases the optimum fin count.

Several enhancement techniques have been reported on single and two-phase forced convection enhancement. However, there are only few papers dealing with natural convection heat transfer enhancement (Guglielmini et al, 1987 and Tanda, 1993). The evaluation of an enhancement technique should be based on the heat transfer performance of both the enhanced and un-enhanced systems with the same size and base-to-ambient temperature difference.

An experimental study was carried out by Tanda (1993) to evaluate the natural convection heat transfer from an array of staggered vertical plates. The effects of interpolate spacing and the plate to ambient temperature difference were investigated. It is reported that an enhancement in the local heat transfer coefficient along the plate assembly compared with those of a continuous vertical plate array having the same height up to a factor of two. Comparison of the average heat transfer results, only little reduction in the heat transfer rates was observed, despite a 28% reduction in heat transfer area.

The studies mentioned reported the performance of natural convection heat transfer of the considered surface geometries. Most of these investigated the effect of geometrical parameters of fin arrays and its fin spacing. In the present work, the arrays are designed taking into consideration suitable and applicable fin spacing and aspect ratios. The effect of fin configuration and array base plate orientation on the heat transfer performance of the tested arrays within the interested range of Rayleigh number is investigated to assess this geometry for natural convection applications. In addition, the study also accounts for temperature variation along the fin height and radiant heat exchanged between the array surface and its surroundings.

Experimental Setup

- Apparatus

The experimental apparatus consists of the fin arrays assembly, wooden compartment, the power supply system necessary to heat up the fin arrays and instrumentation for measuring temperatures of fin arrays surfaces and bulk air, and input electrical power. A schematic view of the test rig is shown in Fig. 1.

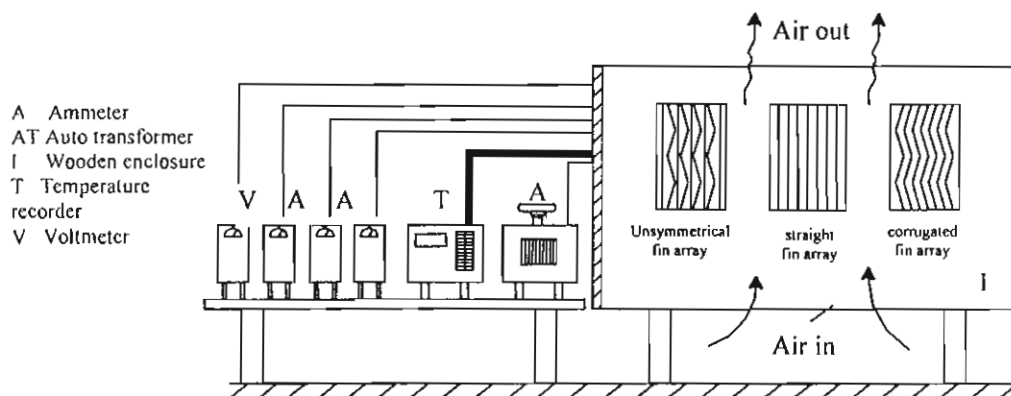

Fig.(1) Test rig (base plates of fin arrays in vertical position).

The vertical fin arrays are mounted on one of the walls of wooden compartment and their base plates can be positioned vertically or horizontally. Designations 1, 2, and 3 are assigned to denote unsymmetrical, straight, and symmetrical corrugated fin arrays respectively. Details of these arrays are depicted in Fig.2.

of heating power to each fin array. The air is allowed to flow from underneath of the enclosure and passes the arrays while moving up.

The experimental setup is deigned to supply a controlled and equal amount

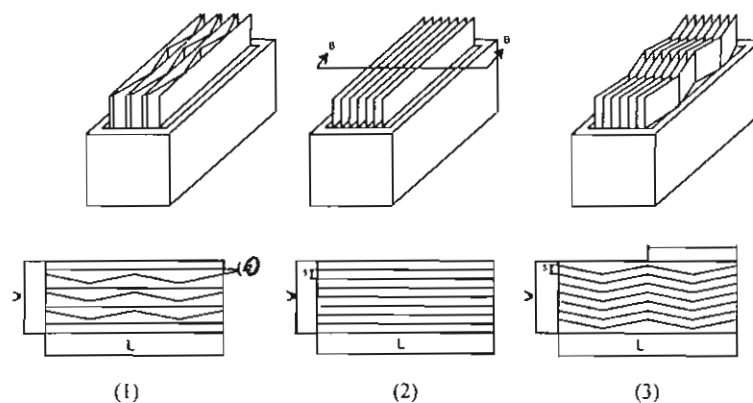

Fig.(2) Tested fin arrays and their top views

1. Unsymmetrical fin array 2. Straight fin array 3. Symmetrical corrugated fin array

- The Fin array assembly

A cross-sectional view of one of the tested arrays is shown in Fig. 3. Each array consists of 7 fins of 1 mm thickness soldered to a 3 mm thick base plate. Both the fins and the base plate are made of brass. An electrical heater of equal resistance is sandwiched by two mica sheets and placed in contact with the fin base plate of each array. The fin base plate assembly is inserted in a wooden box of 10 cm depth filled with polystyrene. With the exception of the fin arrays assembly, the heat unit is completely insulated, and it is assured

that the heat input is entirely directed towards the fin arrays (details can be reviewed in Elshafei and El-negiry (2003)).

- Heating process and Instrumentation

The power is supplied to each of the three heaters by a regulated Ac source via an autotransformer to control the voltage. The heater voltage drop and the current are measured by Voltmeter and Ammeter respectively. It is assured that an equal power input to each of the three heaters is achieved.

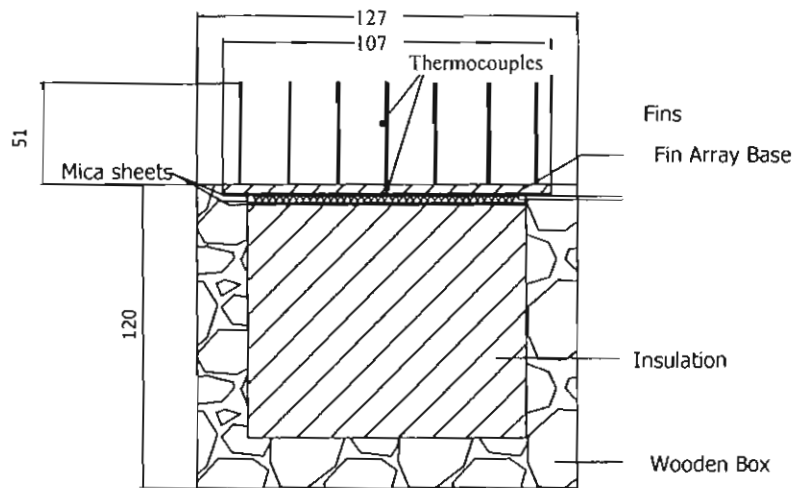

Fig.(3) Cross section in straight fin array assembly at B-B (all dimensions in mm)

The fin arrays and the environmental air are instrumented with insulated fine copper-constantan thermocouples of 0.5 mm diameter (type-T). The average temperature of the fin array is measured by means of 5 thermocouples fixed inside 1 mm holes in the base plate of each array, and another 3 thermocouples glued onto the surface of the middle fin of each array in order to detect variation in fin temperature along its height with respect to the base plate temperature and to stand for how far is the fin efficiency from unity. The ambient temperature is measured by 3 shielded thermocouples of the same type and distributed around the fin arrays inside the enclosure. Experiments on fin arrays were carried out at $29 \pm 0.5^\circ\text{C}$.

The power input to each fin array is transferred to the surroundings mainly by natural convection and radiation. The radiation heat transfer is relatively small (about 10% to 15% of the total power input) because of the low emissivity of the brass used for making the fin arrays ($\epsilon = 0.2$). As will be further described, the radiation heat transfer from each fin

array is determined by calculation and subtracted from the total power input in order to detect the amount of heat transferred by natural convection which will be slightly affected by the uncertainty in the emissivity of the finned surface.

Procedure and Data reduction

The dimensions and aspect ratios of the tested fin arrays are summarized in Table 1. All arrays have equal volume (225 mm x 107 mm x 51 mm). They are tested for five power inputs, 13.0 W, 22.5 W, 33 W, 48 W, and 74 W.

In each experimental run, the electric power is adjusted and delivered to the heater placed underneath the base plate of each array. To attain a steady state conditions, 1 to 2 hour were allowed after every power input change until fixed values of the recorded temperatures of both the arrays surfaces and the surrounding air were observed. A heat balance test for the insulated heated base plate of each array with its environment at the highest power input was carried out. It was observed that the heat leakage rate from the back of the insulated base

plates was almost nothing, indicating that the rate of heat loss can be ignored.

Table I Dimensions and aspect ratios of the tested fin arrays

Array number	1	2	3
Number of fins, N_f	7, 3 corrugated + 4 straight	7, all straight	7, all corrugated
Corrugation angle, θ	14°	0.0	14°
A_s, m^2	0.185	0.183	0.188
S, mm	12.6	13	12.6
L, mm	228	225	232
H, mm	51	51	51
W, mm	107	107	107
S/L	0.055	0.058	0.054
S/H	0.25	0.26	0.25
S/W	0.12	0.12	0.12

- Data reduction

The objective of this investigation is to measure the rate of natural convective heat transfer from each array, and how it is affected by its geometry and its base plate orientation. From dimensional analysis (Raithby and Hollands, 1985, and Karagiozis et al, 1994), the Nusselt number is a function of Ra, and aspect ratios of the fin array. i.e. $Nu = f(Ra, L/S, H/S)$.

The energy balance for each array can be described as:

$$Q_i = Q_c + Q_r + Q_L \quad (1)$$

Where Q_i , Q_c , Q_r , and Q_L , respectively, denote the power input, the convective heat transfer rate, the radiant heat transfer rate, and the rate of heat loss via the back of the base plate of the array. As mentioned before, Q_L is negligible. The rate of heat transfer by convection, Q_c can be calculated from Eq. (1) by knowing the rate of heat transfer by radiation, Q_r .

The rate of radiant heat exchanged from the fin array surface to the surroundings can be written as:

$$Q_r = \sigma A_s F (T_s^4 - T_\infty^4) \quad (2)$$

Where F is the radiant exchange factor which accounts for both geometric and surface emissivity effects on the rate of radiated heat. As reported by Guglielmini et al (1987) and Tanda (1993), the radiant exchange factor, F can be described as:

$$F = \frac{\varepsilon F_{A,\infty}}{1 - (1 - \varepsilon)(1 - F_{A,\infty})} \quad (3)$$

Where the shape factor from the whole fin array surface to the surroundings $F_{A,\infty}$, is as follows:

$$F_{A,\infty} = \frac{(N_f - 2) A_c F_{c,\infty} + 2 A_{ec} F_{ec,\infty}^*}{(N_f - 2) A_c + 2 A_{ec}} \quad (4)$$

In the above equation, A_c , $F_{c,\infty}$ are the area and shape factor of repetitive channel respectively and A_{ec} , $F_{ec,\infty}^*$ are the area and shape factor of end side channel. The contribution of the two end side channels could be eliminated since their area is relatively small with respect to repetitive channel areas.

The value of repetitive channel shape factor, $F_{c,\infty}$ of the tested fin arrays in the present investigation is determined from calculated results using the configuration factor algebra reported by Guglielmini et al (1987), taking the aspect ratios of those fin arrays into account and used to calculate the radiant exchange factor through equations (3) and (4).

Assuming the temperature of ambient air is T_∞ and nonreflecting surroundings, the obtained values of the factor F for the tested fin arrays were also checked by measured values for similar fin arrays of the ratio S/H of 0.15 and

0.45 reported by Karagiozis et al (1994), and their values are found to be very close. The net radiation heat transfer Q_r from the fin array can then be evaluated from Eq. (2)

Returning to Eq. (1), Q_c can be determined by measured value of Q_i and the calculated value Q_r . The average convective heat transfer coefficient is:

$$h_{av} = \frac{Q_c}{(A_b + A_f \eta_f)(T_s - T_\infty)} \quad (5)$$

Where A_b is the bare area of the base plate and η_f is the fin efficiency; the ratio of the actual heat dissipated from the fin and that which would exist if the entire surface is at the temperature of the heated base plate. i.e. $\eta_f = \frac{\tanh mH_f}{mH_f}$,

and parameter $m = \sqrt{\frac{p h_{av}}{k_f A_c}}$.

In equation (5), the surface temperature T_s and the ambient temperature T_∞ are determined by averaging the readings of the thermocouples embedded in the base plate of the array and the shielded ones distributed in the enclosure respectively. A simple program is built to calculate the average heat transfer coefficient by iteration using Newton-Raphson method.

For a dimensionless presentation, Nusselt and modified Rayleigh numbers are introduced. The evaluation of both numbers is based on the fin spacing S . The effect of flow traveling length is considered and depends on whether the fin array base plate is vertically or horizontally oriented. For vertical base plate orientation:

$$Nu = \frac{hS}{k} \quad (6)$$

$$Ra_{sl}^* = \frac{g \beta_\infty \Delta T S^3}{\alpha \nu} \left(\frac{S}{L} \right) \quad (7)$$

For horizontal base plate orientation, the height of the fin array, H is introduced instead of its length, L . The modified Rayleigh number follows as:

$$Ra_{sh}^* = \frac{g \beta_\infty \Delta T S^3}{\alpha \nu} \left(\frac{S}{H} \right) \quad (8)$$

All thermo-physical properties used in the above equations are evaluated at the film temperature T_f which is defined as the average of T_∞ and T_s , except for β value calculated at the ambient temperature T_∞ . These properties may be found in any heat transfer textbook (see Incropera and Dewitt (1990)).

Results and Discussion

Measured value of ΔT for different power inputs are shown in Fig. 4 for the three vertical fin arrays when their base plates are in vertical orientation. It can be seen that for a certain power input, the unsymmetrical fin array has the highest ΔT . As a consequence, the average convective heat transfer coefficient of this array will be the lowest, while the straight fin array has the highest one as can be noted from Fig. 5. The heat transfer coefficient of the straight fin array is increased by about 15% more than that of the unsymmetrical fin array and about 10% more than that of the symmetrical corrugated fin array. This may be related to the high resistance to natural air movement accompanied with the corrugation of fins in both unsymmetrical and symmetrical corrugated fin arrays where the air enters near the bottom of the fin arrays and moves up through the

gaps between fins. The discrepancy between the values of Nu for the three arrays is seen to be decreased with the increase of the modified Rayleigh number, Ra_{SL}^* .

The variation of ΔT versus power input for the three arrays when their base plates are oriented horizontally and facing up is shown in Fig. 6. As expected, the values of ΔT increases with the increase of power input. The discrepancy due to change of fin configuration is smaller than that when the arrays are mounted vertically. The values of ΔT become much closer with increasing the power input. This resulted in small differences between the average heat transfer coefficients for the three arrays, especially at high modified Rayleigh number, Ra_{SH}^* as seen in Fig. 7. The percentage increase in the average heat transfer coefficient for the straight fin array is about 10% related to that of the unsymmetrical array and about 4% related to that of the symmetrical corrugated one. This is related to less resistant to air movement due to shortening of air traveling length and the occurrence of both chimney effect like and the inflow from both ends of the fin array as reported by Harahan, and McManus (1967) and Bilitzky (in Kraus and Bar-Cohen, 1995).

The effect of base plate orientation on the heat transfer for the three tested arrays is shown in Fig. 8. Over the tested range of Rayleigh number, the Nusselt number for the straight fin array of vertical base plate is up to 10% higher than for that array when its base plate oriented horizontally and this difference decreases with the increase of Rayleigh number. However, the discrepancies between the values of Nusselt numbers for both unsymmetrical and symmetrical corrugated fin array are 4% and 2% respectively and seemed to

be diminished with the increase of Rayleigh number.

As a comparison, the heat transfer results of the straight fin array with vertical base plate are compared with the available literature and are shown in Fig. 9. It can be observed that the present results have the same trend and over predicted by about 30 to 40% within the tested range of the modified Rayleigh number. These discrepancies may be attributed to using different fin array material and configurations.

Concluding Remarks

Experiments were performed to investigate natural convection heat transfer from three arrays of the same volume and have different fin configuration with their base plates mounted vertically and horizontally while the fins are running vertically at several power inputs. The main points related to heat transfer from these arrays are summarized as follows:

- For vertical base plate orientation, the straight fin array has the highest heat transfer coefficient and the difference between Nusselt numbers for all arrays decreases with the increase of Ra_{SL}^* .
- For horizontal base plate orientation, the values of Nusselt numbers becomes closer, specially at high vales of Ra_{SH}^* , and the effect of fin configuration is smaller than that of vertical base plate.
- The effect of base plate orientation is more pronounced for the straight fin array and seems to be diminished for both unsymmetrical and symmetrical corrugated fin arrays at high Rayleigh number.

References

- Cathy, B., 2001, "Heat Sinks in Natural Convection: Optimum Fin Spacing," Cooling Zone Newsletter,
- Christopher, A.S., 2002, "Optimize Fin Spacing: How close is too close," Power Electronics Technology Online.
- Elliott, R., ESP, 2003, "The Design of Heatsinks," ESP-Heat sink Design and Transistor Mounting.
- Elenbaas, W., 1942, "Heat Dissipation of Parallel Plates by Free Convection,"
- Elshafei, E.A.M, and El-Negiry, E.A, 2003, "Effect of Fin Configuration on the Performance of Longitudinal Fin Arrays," Mansoura Engineering Journal, (MEJ), Vol.28, No. 2, pp 57-70.
- Guglielmini, G., Nannel, E., and Tanda, G., 1987, "Natural convection and radiation heat transfer from staggered vertical fins," Int. J. Heat Mass Transfer, Vol. 30, pp. 1941-1948.
- Guvenc, A. and Yuncu, H., 2001 "An Experimental investigation on the performance of fins on a horizontal base in free convection heat transfer," Online publication; Heat and mass transfer- abstract vol.37 Issue 4/5.
- Harahap, F., and McManus, H.N., 1967, "Natural Convection Heat Transfer from Horizontal Rectangular Fin Arrays," ASME J. of Heat Transfer, Vol.89, pp.32-38.
- Hernandez, J., Zamora, B., and Campo, A., 1993, "Natural Convection Laminar Flow in Arrays of Vertical Parallel Plates," PHOENICS J. of CFD & its applications, Vol.6, No.2, pp 171-190.
- Incropera, F.P., and DeWitt, D.P., 1990, Fundamentals of Heat and Mass Transfer, 3rd edition, John Wiley and Sons, New York.
- Karagiozis, A., Raithby, G.D., and Hollands, K.G.T., 1994, "Natural Convection Heat Transfer From Arrays of Isothermal Triangular Fins in Air," ASME J. of Heat Transfer, Vol.116, pp.105-110.
- Kraus, A.D., and Bar-Cohen, A., Design and Analysis of Heat Sinks, John Wiley and Sons, New York, NY, 1995.
- Malhammar, A., 2003, " A Volumetric Approach to Natural Convection," <http://www.coolingzone.com/Guest/News/NL.FEB/Ake>
- Raithby, G.D., and Hollands, K.G.T., 1985, Handbook of Heat Transfer Fundamentals, 2nd ed. McGraw Hill, New York.
- Simons, R.E, 2001, "Simplified Formula for Estimating Natural convection Heat Transfer Coefficient on Flat Plate," Electronics Cooling, Vol.7, No.3, pp 12-13.
- Simons, R.E., 2002, "Estimating Natural Convection Heat Transfer for Arrays of Vertical Parallel flat plates," Electronics Cooling online, pp.1-5.
- Tanda, G., 1993, "Natural Convection Heat Transfer from a Staggered Vertical Plate Array," ASME J. of Heat Transfer, Vol.115, pp.938-945.

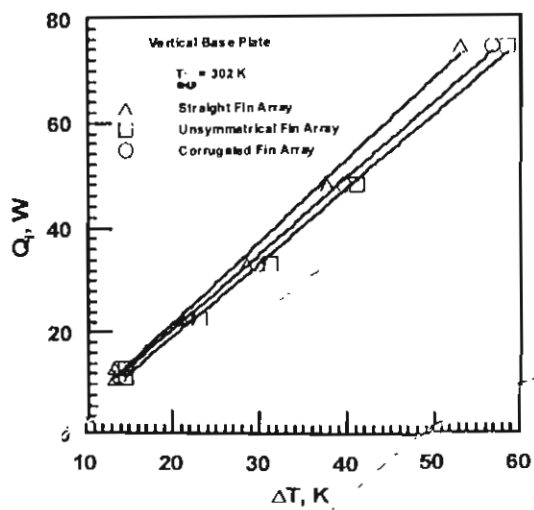

Fig. 4 Temperature difference variation with power input.

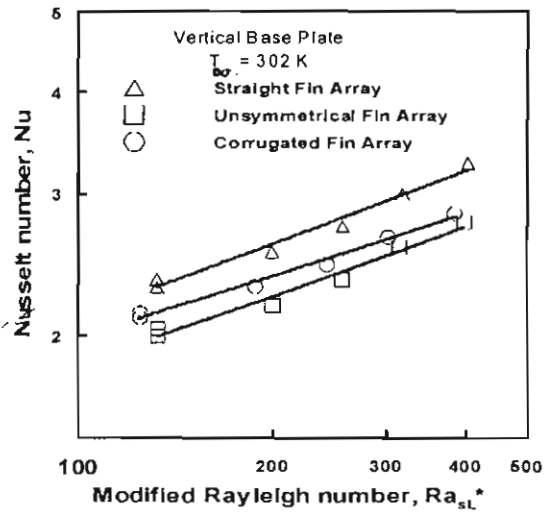

Fig. 5 Nusselt number versus modified Rayleigh number.

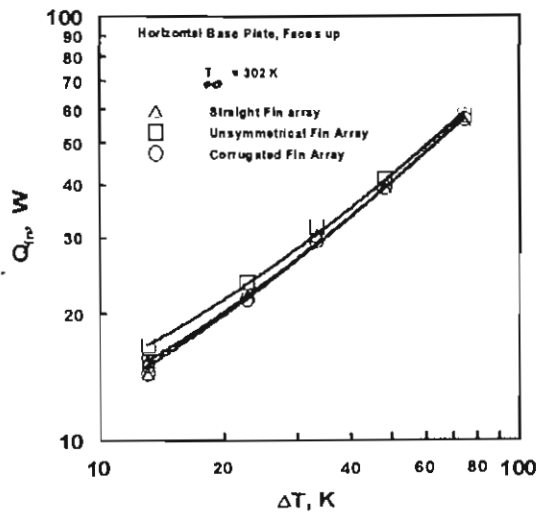

Fig. 6 Temperature difference variation with input power.

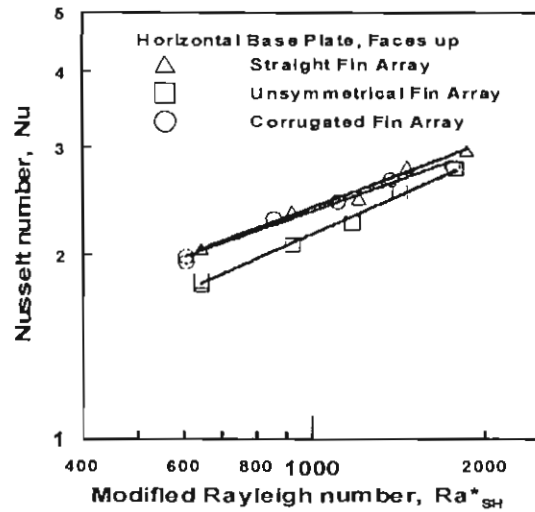

Fig. 7 Nusselt numbers versus modified Rayleigh number.

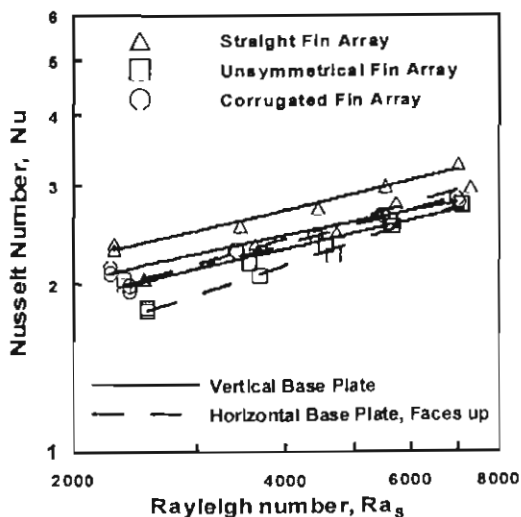

Fig. 8 Nusselt numbers versus Rayleigh number for the three fin arrays.

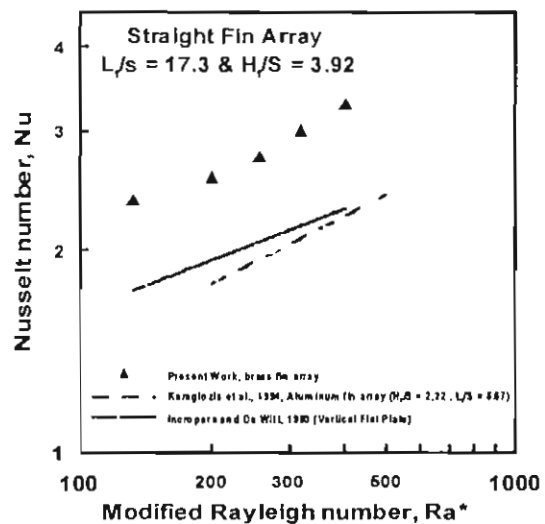

Fig. 9 Comparison of the present data with published data in case of vertical base plate.