

AN APPROACH TO THE OPTIMIZATION OF SEWING
CONDITIONS

المشالية لظروف حياكة الاقمشة

BY

HEMDAN A. ASO-TALEB

Textile Engineering Dept., Faculty of Engineering, Mansoura University,
Mansoura, Egypt.

الخلاصة - هذا البحث يهتم بدراسة تأثير ظروف الخياطة مثل المسافة بين خط الحياكة وحافة القماش، اتجاه الخياطة (زاوية قص القماش بالنسبة لاتجاه اللحمة)، عدد الغرز في وحدة الطول من الخياطة ونمرة خيط الحياكة على متانة واستطالة الخياطة في الاقمشة المنسوجة وذلك عند استخدام غرزة عادية وأخرى سلسلة ذو خيط واحد. وأمكن استخدام طريقة تصميم التجارب لايجاد قيم لهذه العوامل للحصول على أعلى متانة. ومن النتائج اتضح أن القيم المثلى لهذه العوامل عند استعمال غرزة عادية: هي أن تكون المسافة بين خط الحياكة وحافة القماش مساوية 2 سم، خط الخياطة يكون موازياً لخيط السدا، بحيث أن عدد الغرز في السم يساوي 5 مع استعمال خيط حياكة بنمرة 3/70 انجلىزى. ولكن عند استعمال غرزة سلسلة ذو خيط واحد: هي أن تكون المسافة بين خط الحياكة وحافة القماش مساوية 1 سم، خط الخياطة يكون موازياً لخيط السدا، وعدد غرز الخياطة في السم يساوي 3 مستعملاً خيط حياكة بنمرة 3/50 انجلىزى. أيضاً ظروف التشغيل المثالية بالنسبة لاستطالة قطع الخياطة أمكن تحديدها لكل من النمرزة العادية والغرزة السلسلة. متانة الخياطة للاقمشة المنسوجة عند استعمال غرزة سلسلة ذو خيط واحد وجد أنها أعلى بالمقارنة بمتانة الاقمشة المخيطة بفرز عادية والعكس أمكن التوصل اليه بالنسبة لاستطالة قطع الخياطة.

ABSTRACT- The study reported in this work concerns the influences of sewing conditions such as the distance between seam line and fabric edge, seam direction (cutting angle relative to weft yarns), number of stitches per unit length of seam and the linear density of sewing threads on the seam breaking strength and extension of woven fabrics for both double lock and single-thread chain stitches. The application of fractional factorial design to optimize the operating conditions of sewing machine is demonstrated. The optimum sewing conditions when using double lock stitch are the distance between seam line and fabric edge is 2 cm, the seam line is parallel to the selvedge using 5 stitches/cm and the linear density of sewing thread is 70/3 Ne. But when using single-thread chain stitch the optimum conditions are the distance between seam line and fabric edge is 1 cm, the seam line is parallel to the selvedge using 3 stitches/cm of 50/3 Ne sewing thread count. Also the optimum sewing conditions for seam extension could be determined for both the double lock and the single -thread chain stitches. When using single-thread chain stitch, it gives the highest seam strength and the lowest seam extension compared to the common double lock stitch.

1- INTRODUCTION

In the present time, joining the parts of garment can be achieved by the following methods: sewing threads, sticking and combination of them /1/.

The common and important problem in cloth manufacture is improving the quality and the outside view of garments. The quality of garments

depends upon many factors correlated with each other such as stitch type, stitch density, sewing thread count, seam direction and so on.

The garments during wearing are subjected to different mechanical effects e.g. tension, pressure, bending, torsion and so on. Therefore, it is necessary to choose the optimum sewing conditions to obtain high seam strength, durability and a beauty of the outside view of the garments.

Sheta A. /2/ stated that, lock stitch seam strength can be obtained by multiplying the statistical minimum loop strength of the sewing thread by the correction factor. The correction factor could be determined theoretically as a function of number of stitches/cm, sewing thread breaking extension, diameter and fabric parameters. The author mentioned that correction factor increases with the increase of number of stitches/cm and sewing thread diameter. The correction factor is ranging from 0.91 to 0.96, this means that for the lock stitch seam strength is mainly dependent on the minimum loop strength of the sewing thread.

Burtonwood B. and Chamberlain N. /3/ showed that as stitch density increases seam strength in a given fabric linearly increases up to the point where increasing stitch density causes a significant fabric damage.

Щаньгина В. /1/ studied the seam extension of different fabric constructions. It was found that both weave design and fabric construction does not influence seam extension.

The optimization of the sewing conditions by using fractional factorial design /4/ has not yet been studied in other work. In the present study, an attempt is made to demonstrate the application of this design and to determine the five optimum variables.

The purpose of this study was to determine optimum sewing conditions such as the distance between seam line and fabric edge, cutting angle relative to weft yarns, number of stitches per unit length of seam, the sewing thread linear density and the stitch type.

2- DESIGN EXPERIMENT

A fractional factorial design /4/ was chosen to investigate all the five variables: (X1) the distance between seam line and fabric edge was from 0.5 to 2.5 cm; (X2) cutting angle relative to weft yarns was varied from 0° to 90°; (X3) stitch density was varied from 2 to 6 stitches/cm; (X4) stitch type was varied from double lock stitch to single-thread chain stitch as shown in figures 1 (a,b) and (X5) sewing thread linear density was varied from 40/3 to 80/3 (Ne) and spun from combed cotton (Giza 75, noil 20%). The sewing threads were singed, mercerized and dyed. The fractional factorial design for five variables is given in Table I.

The response Y (seam strength/stitch) and seam extension are given by a second-order polynomial, i.e.:

$$Y = b_0 + \sum_{i=1}^M b_i X_i + \sum_{i=1}^M \sum_{j=1}^M b_{ij} X_i X_j,$$

where X_i = i th variable,
 M = number of variables, and
 b_0 , b_i and b_{ij} = regression coefficients associated with the variable.

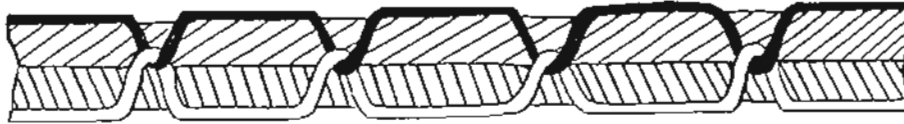

Fig. 1(a): Double lock stitch seam.



Fig. 1(b): Single-thread chain stitch seam.

Table I: Experimental Design.

No.	Levels of Variables					Seam Strength (Kg)		Seam Extension (%)	
	X ₁	X ₂	X ₃	X ₄	X ₅	Exp.	Cal.	Exp.	Cal.
1	-	-	-	-	-	0.0275	0.0207	19.395	19.388
2	+	-	-	+	+	0.8030	0.7962	4.013	4.006
3	-	+	-	+	+	0.6292	0.6360	3.146	3.153
4	+	+	-	-	-	0.7608	0.7676	8.014	8.021
5	-	-	+	+	-	0.3938	0.3870	5.847	5.854
6	+	-	+	-	+	0.0937	0.0869	19.903	19.910
7	-	+	+	-	+	0.2216	0.2284	4.430	4.422
8	+	+	+	+	-	0.9981	1.0049	9.131	9.124

The actual levels of the five variables are given in Table II.

Table II: Actual Levels.

Variable	Level	
	-1	+1
X ₁ = Distance between seam line and fabric edge (cm)	0.5	2.5
X ₂ = Cutting angle relative to weft yarns (degree)	0	90
X ₃ = Stitch density (S/cm)	2	6
X ₄ = Stitch type	double lock	single-thread chain
X ₅ = Sewing thread linear density (Ne)	40/3	80/3

3- EXPERIMENTAL ANALYSIS

Plain weave cotton fabric of 156 g/m^2 with the following constructional details was used in this study:

Thread spacing: 50 ends/inch and 39 picks/inch;
Yarn count : 15 Ne for both warp and weft yarns,

Each fabric sample was cut into two approximately equal strips 15 cm long and 5 cm wide as shown in Fig. 2. Superimpose one strip on the other for sewing. The two strips were joined together by means of the prescribed sewing conditions as shown in Fig. 2. Thus the seam assembly specimens could be prepared from fabric samples on both Juki DDL-555 and Juki ML-111 sewing machines for obtaining double lock and single-thread chain stitches respectively. Also the tensions of the sewing threads could be adjusted to form the prescribed stitch types.

The breaking load and extension of seam assembly specimens were determined when the load was applied perpendicularly to the seam direction, using cut strip method.

As shown in the experimental design in Table I, the seam strength/stitch was calculated [3] from the following expression:

$$\text{Seam strength/stitch} = \frac{\text{The breaking load of the seam in a given length}}{\text{number of stitches in this length}} = \frac{S}{NW}$$

where, S is the breaking load of the seam (Kg);

W is the specimen width (cm); and

N is the number of stitches/cm.

The results of seam strength/stitch were analysed using the UK 401 computer. The regression coefficients were determined taking into consideration the significant terms only. The response-surface equations for both seam strength and extension are given in Table III with the correlation coefficients between the experimental values and the calculated values obtained from the response-surface equations. The response surfaces agree fairly well with the experimental results, as can be observed from the high correlation coefficients. Contour lines were constructed by using the response-surface equations for both double lock and single-thread chain stitches.

Table III: Response-surface Equations.

Response	Response-surface Equation	Correlation Coefficient
$Y_1 = \text{Seam strength/stitch (Kg)}$	$Y_1 = 0.491 + 0.173 X_1 + 0.168 X_2 - 0.064 X_3 + 0.215 X_4 - 0.054 X_5 - 0.054 X_1 X_3 + 0.022 X_1 X_4$	0.99986
$Y_2 = \text{Extension (\%)}$	$Y_2 = 9.235 + 1.030 X_1 - 3.055 X_2 + 0.593 X_3 - 3.701 X_4 - 1.362 X_5 + 3.659 X_1 X_3$	0.59998

From analysis the mathematical model of seam strength, it could be observed that when changing the factors within the chosen interval the factor (X_4) has a great influence afterwards the factors X_1, X_2, X_3, X_5 and the interaction $X_1 X_3$ and $X_1 X_4$ respectively. Seam strength

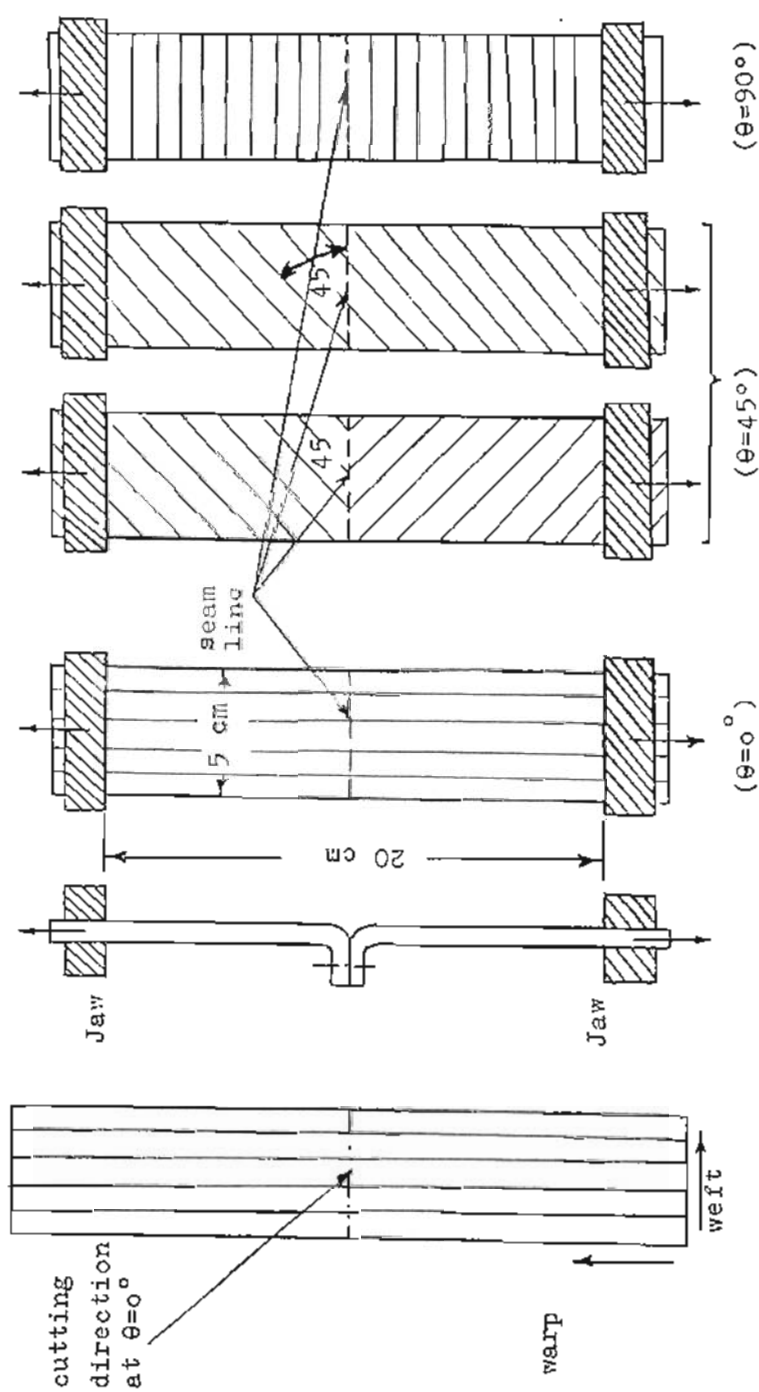

Fig.2. Methods of changing seam direction (cutting angle relative to weft yarns θ°)

increases with using the level + 1 of X_1 , X_2 and X_4 and with a decrease of the variables X_3 and X_5 .

For the mathematical model of seam extension, it could be noticed that with an increase of the factors X_1 , X_3 and with using the level -1 of X_2 , X_4 and X_5 seam extension increases.

4- RESULTS AND DISCUSSION

4.1- Seam Strength

Figures 3 & 4 show the effect of seam direction (cutting angle relative to weft yarns) and the distance between seam line and fabric edge on seam strength/stitch for both double lock stitch ($X_4 = -1$) and single-thread chain stitch ($X_4 = +1$). The response surface is easily influenced by the variables X_1 , X_2 and X_4 . There is a large increase in seam strength when X_1 , X_2 and X_4 are at the highest level. This means that when seam line is parallel to warp yarns seam strength increases. This may be due to the higher density of warp yarns per unit length compared to the weft ones and the low mobility of warp yarns. Also with an increase of the distance between seam line and fabric edge up to 2.5 cm the seam strength gradually increases. This is probably due to the higher ravelling and slippage resistance of yarns in this case.

Figures 5 & 6 show the effect of cutting angle (X_2) and stitch density (X_3) on seam strength for both the levels + 1 & - 1 of variable X_4 (stitch type). Seam strength significantly increases when X_2 and X_4 are at the highest level and X_3 (stitch density) is at the lowest level. This may be due to the fact that when stitch density increases significant fabric damage is occurred and consequently seam strength decreases.

Figures 7 & 8 show the effect of cutting angle (X_2) and linear density of sewing threads (X_5) on seam strength for the two studied types of stitches. Any decrease in the variable X_5 (i.e. linear density of sewing thread becomes high) the seam strength will slightly increase for both single-thread chain and double lock stitches. Also the results showed that the seam strength in the case of using single-thread chain stitch is higher than that in the case of using double lock stitch. This can be explained on the basis of the degree of tightness and cohesion achieved during using chain stitch. Also seam strength slightly increases as the linear density of sewing thread increases. This is mainly due to the higher tensile strength of coarse sewing threads compared to the fine ones.

4.2- Seam Extension

Figures 9 & 10 show the effect of cutting angle (X_2) and the distance between seam line and fabric edge (X_1) on seam extension for both double lock stitch (at $X_4 = -1$) and single-thread chain stitch (at $X_4 = +1$). Seam extension increases when X_2 and X_4 are at the lowest level and (X_1) is at the highest level. The maximum value of seam extension is occurred when using double lock stitch because it consists of two sewing threads but single-thread chain stitch consists of one thread. In addition to this, during the breakage of the single sewing thread in the case of chain stitch, the fast unwinding of stitches can be occurred such as in knitted fabrics. Also the maximum value of seam extension is occurred when seam line is as possible parallel to weft yarns because of the low density of weft yarns in the direction of seam line. Therefore, it causes large freedom of sewing threads to be stretched, consequently fabric seam extension increases. And as the distance between seam line and fabric edge increases up to 2.5 cm seam extension increases. This may be due to increasing the ravelling and slippage resistance.

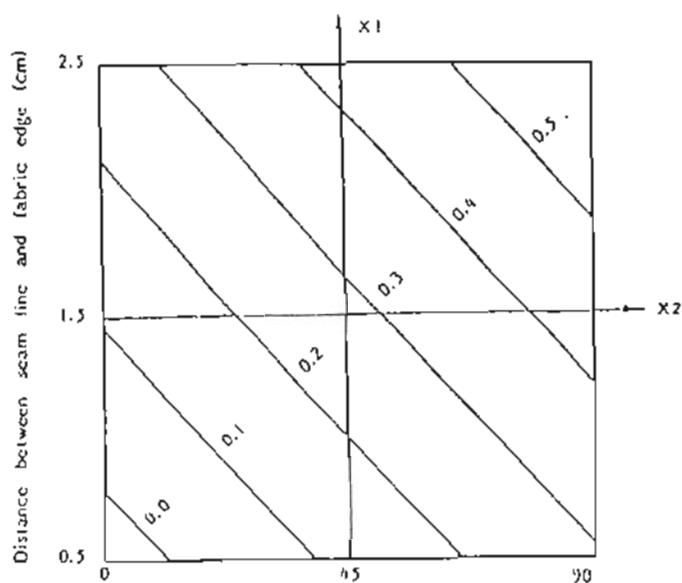

Cutting angle relative to weft yarns (degree)

Fig.3: Contours for seam strength for -1 level of variable X_4 (double lock stitch) ($X_3 = 0$, $X_5 = 0$).

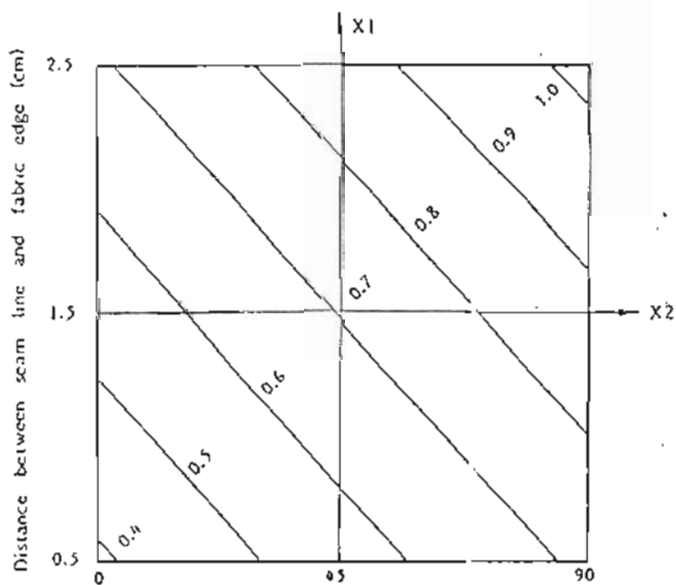

Cutting angle relative to weft yarns (degree)

Fig.4: Contours for seam strength for +1 level of variable X_4 (single-thread chain stitch) ($X_3 = 0$, $X_5 = 0$).

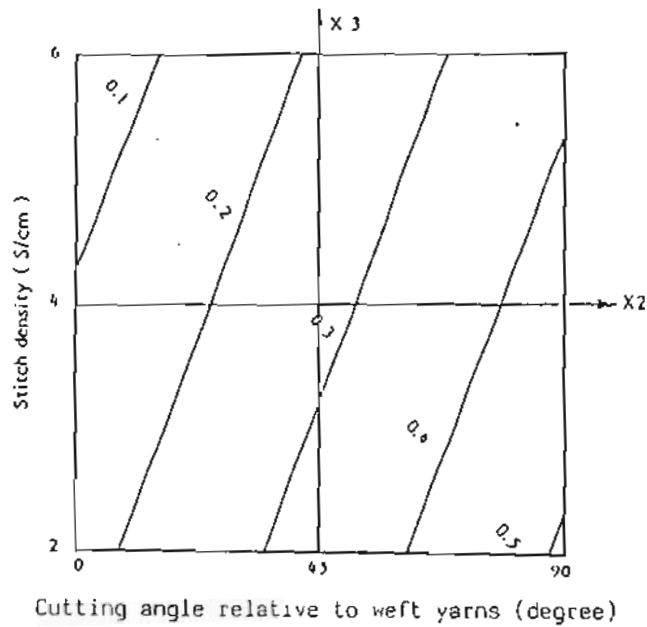

Fig.5: Contours for seam strength for -1 level of variable X_4 (double lock stitch) ($X_1 = 0$, $X_5 = 0$).

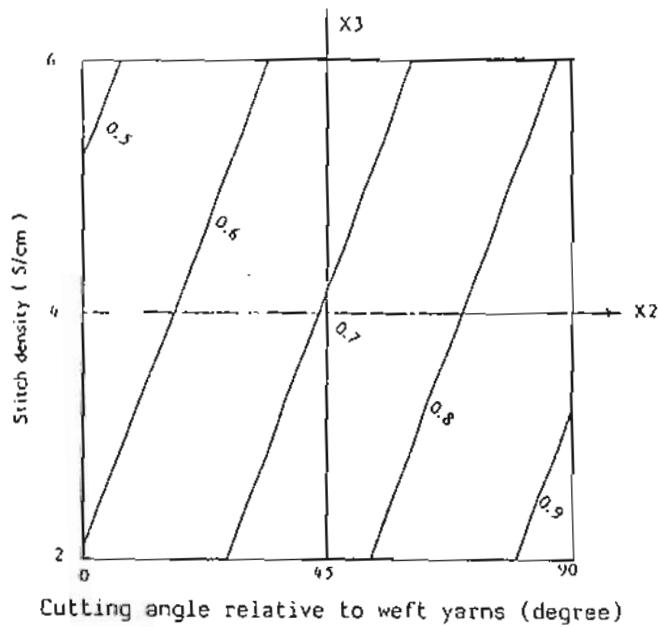

Fig.6: Contours for seam strength for +1 level of variable X_4 (single - thread chain stitch) ($X_1 = 0$, $X_5 = 0$).

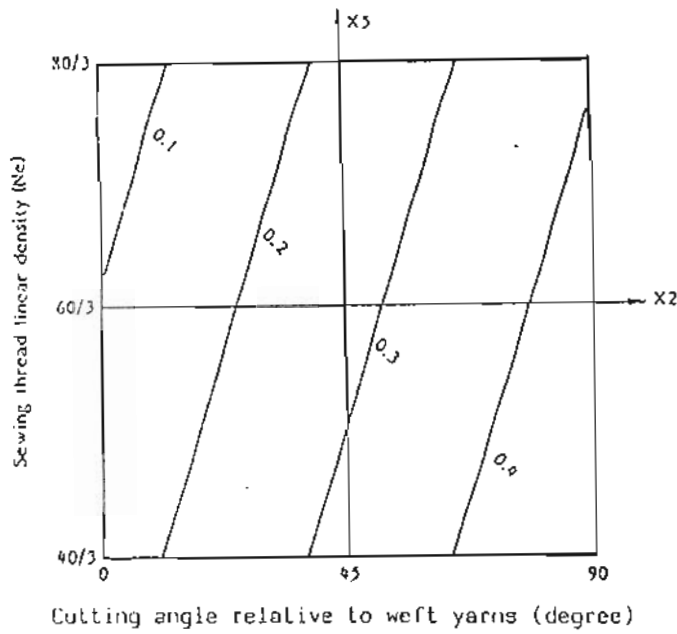

Fig.7: Contours for seam strength for -1 level of variable X_4 (double lock stitch) ($X_1 = 0, X_3 = 0$).

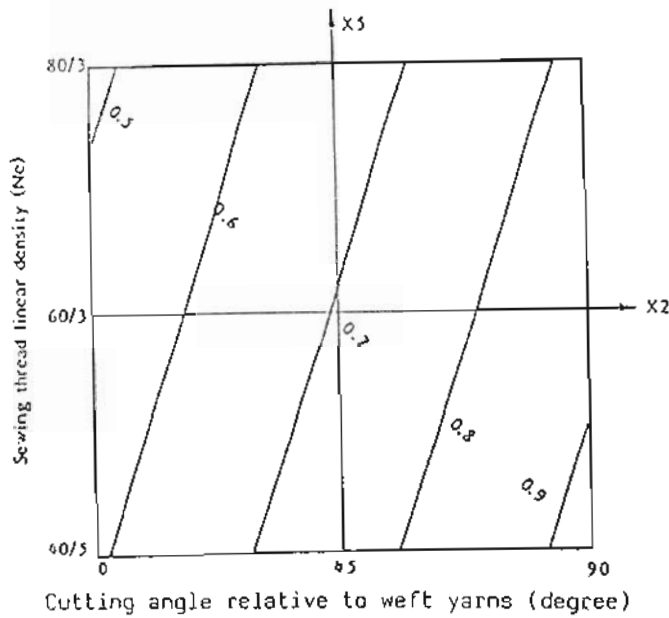
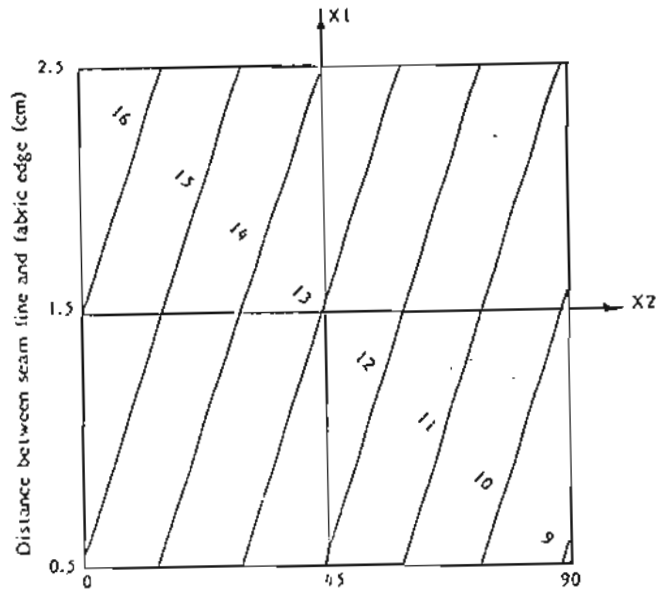
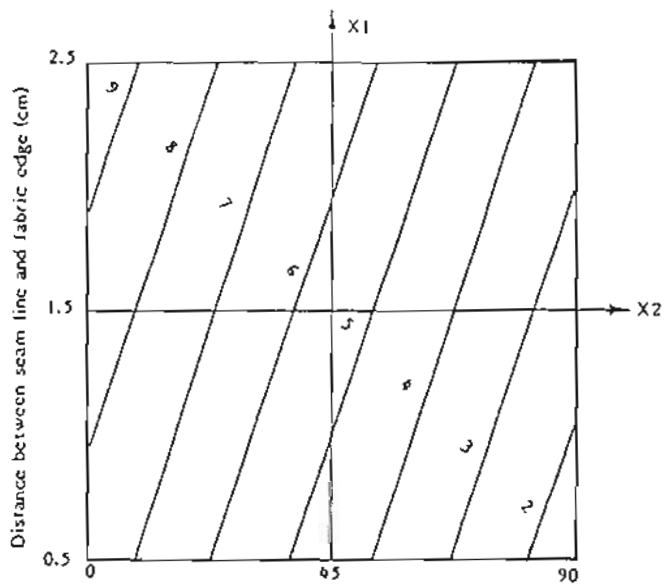

Fig.8: Contours for Seam strength for +1 level of variable X_4 (single-thread chain stitch) ($X_1 = 0, X_3 = 0$).



Cutting angle relative to weft yarns (degree)

Fig.9: Contours for seam extension for -1 level of variable X_4 (double lock stitch) ($X_3 = 0$, $X_5 = 0$).



Cutting angle relative to weft yarns (degree)

Fig.10: Contours for seam extension for +1 level of variable X_4 (single-thread chain stitch) ($X_3 = 0$, $X_5 = 0$).

Figures 11 & 12 show the influence of seam direction (X_2) and stitch density (X_3) on seam extension for both double lock and single-thread chain stitches. The maximum value of seam extension could be obtained at 6 stitches/cm provided that seam line is parallel to weft yarns. This can be explained by the fact that the higher sewing thread extension the longer stretched stitch length and consequently with increase of number of stitches per unit length, the seam extension slightly increases. Seam extension for double lock stitch is higher, than that for single-thread chain stitch. This is may be owing to the higher elasticity of double lock stitch compared to the single-thread chain stitch as discussed previously. The results showed that both stitch type and seam direction affect to a great extent on seam extension compared to the stitch density.

Figures 13 & 14 show the effect of seam direction (cutting angle) and linear density of sewing thread on seam extension. Stitch type influences to a great extent on seam extension more than the linear density of the sewing thread. Seam extension increases as the linear density was increased. This is may be due to the higher extensibility of the coarse sewing threads.

4.3- Optimum Values

4.3.1- Seam strength

The highest values of seam strength of woven fabrics could be achieved by duplicating the Figures (3,5 & 7) together for the level-1 of variable X_4 (double lock stitch) as shown in Fig. 15. Similarly, the Figures (4,6 & 8) could be duplicated together for the +1 level of variable X_4 (single-thread chain stitch) as shown in Fig. 16. As can be observed from Fig. 15 which the double lock was used, the optimum sewing conditions would be found in the optimum zone specially in point F which the distance between seam line and fabric edge (X_1) is equal to 2 cm and stitch density (X_3) is equal to 5 stitches/cm and seam direction (X_2) is parallel to warp yarns and sewing thread size (X_5) is 70/3 Ne will achieve the superior seam strength of woven fabrics.

But from Fig. 16 at point Z when the distance between seam line and fabric edge is equal to 1 cm and stitch density (X_3) is equal to 3 stitches/cm with 50/3 Ne sewing thread count and seam direction is parallel to warp yarns using chain stitch, the highest values of seam strength/stitch could be obtained

4.3.2- Seam extension

Also from Fig. 17 (duplicated from figures 9, 11 & 13 together) for seam extension in the case of using double lock stitch the optimum sewing conditions could be found at point (G) where the distance between seam line and fabric edge is equal to 1.5 cm. and seam line is parallel to weft yarns and stitch density is equal to 4 stitches/cm from 60/3 Ne sewing thread count.

Whereas Fig. 18 represents the Figures(10, 12 & 14) together for single-thread chain stitch. From this figure it could be noticed that the optimum sewing conditions for obtaining the highest seam extension was found at point H which the distance between seam line and fabric edge is 1.2 cm and seam line is parallel to weft yarns and number of stitches/cm is equal to 3 with using 50/3 Ne sewing thread size. These optimum conditions are very important for sewing stretched woven and/or knitted fabrics.

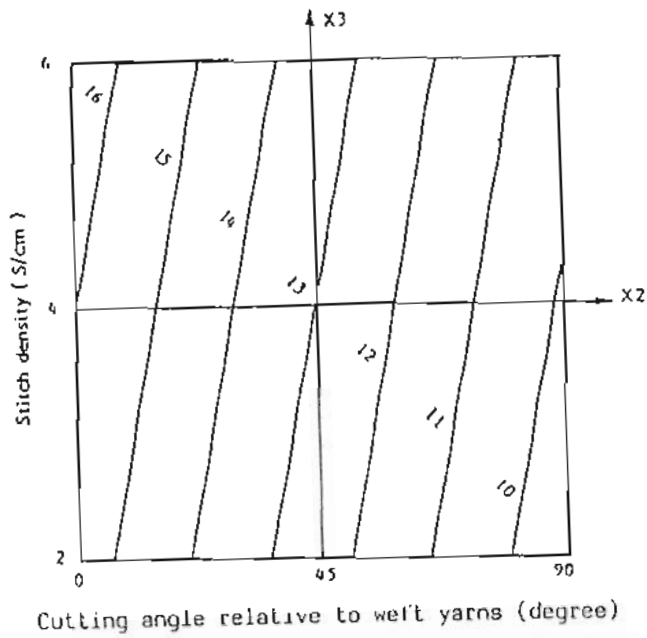

Fig.11: Contours for seam extension for -1 level of variable X_4 (double lock stitch) ($X_1 = 0$, $X_5 = 0$).

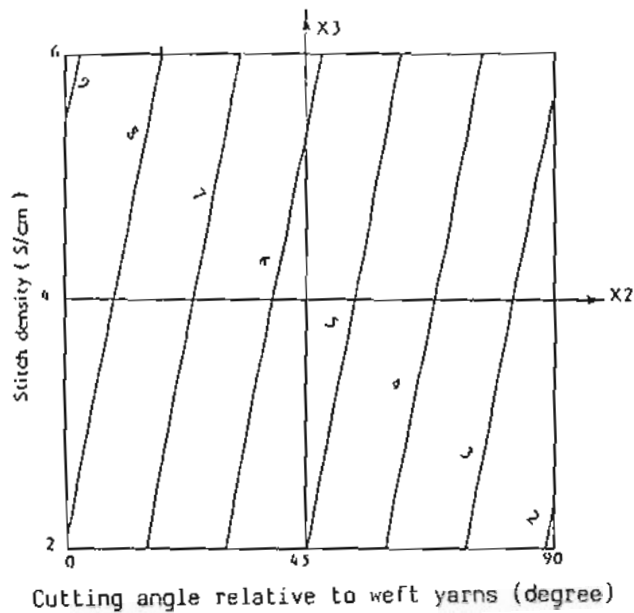

Fig.12: Contours for seam extension for +1 level of variable X_4 (single-thread chain stitch) ($X_1 = 0$, $X_5 = 0$).

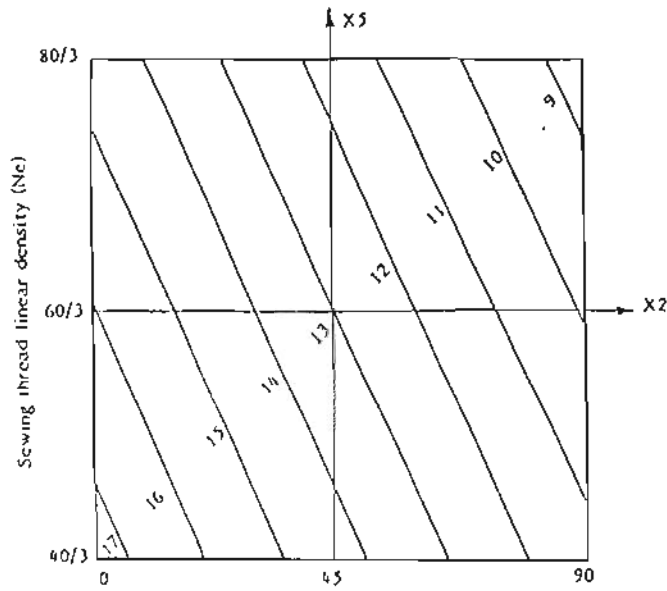

Fig.13: Contours for seam extension for -1 level of variable X_4 (double lock stitch) ($X_1 = 0$, $X_3 = 0$).

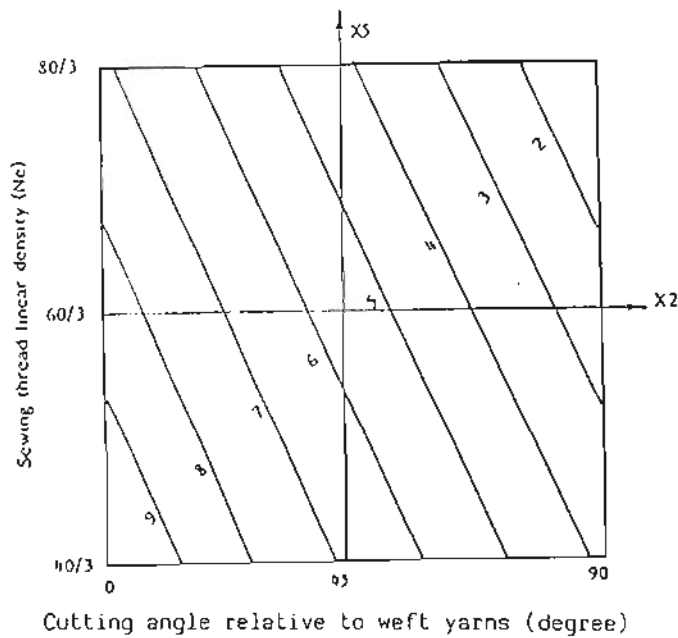

Fig.14: Contours for seam extension for +1 level of variable X_4 (single-thread chain stitch) ($X_1 = 0$, $X_3 = 0$).

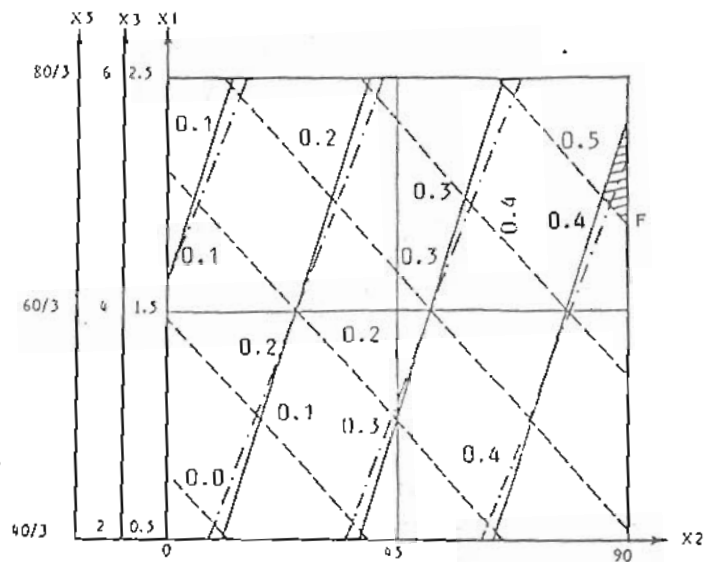

Fig. 15. The duplex cross sections of seam strength for double lock stitch.

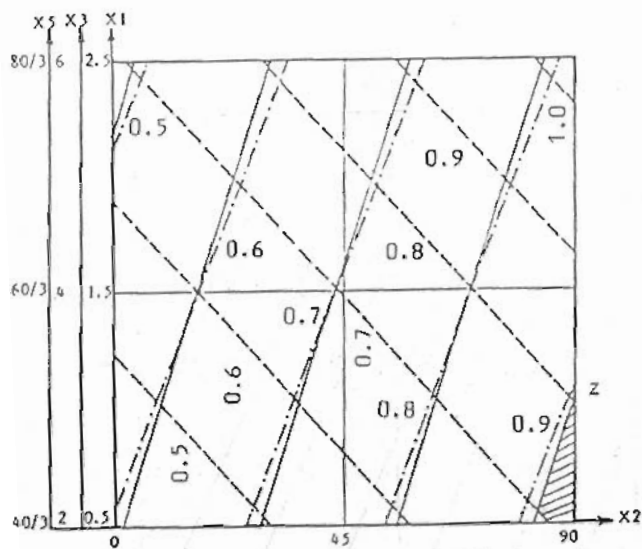

Fig. 16. The duplex cross sections of seam strength for single-thread chain stitch.

- Cross section of $(x_2 - x_1)$ at $x_3 = 0, x_5 = 0$
- - - - - Cross section of $(x_2 - x_3)$ at $x_1 = 0, x_5 = 0$
- Cross section of $(x_2 - x_5)$ at $x_1 = 0, x_3 = 0$

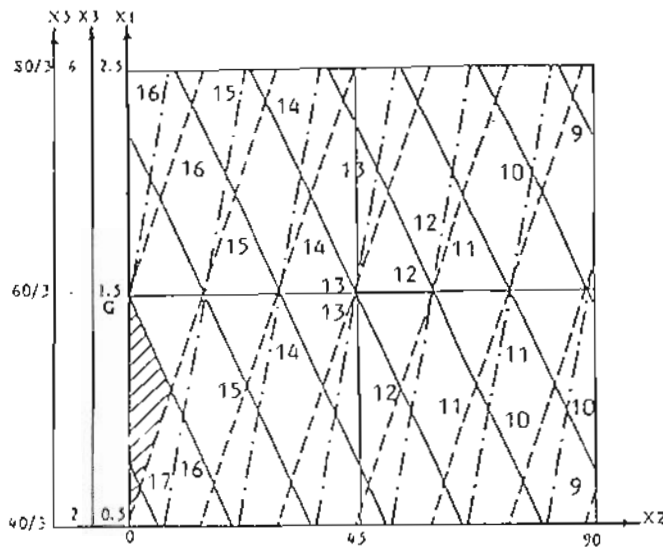

Fig. 17. The duplex cross sections of seam extension for double lock stitch.

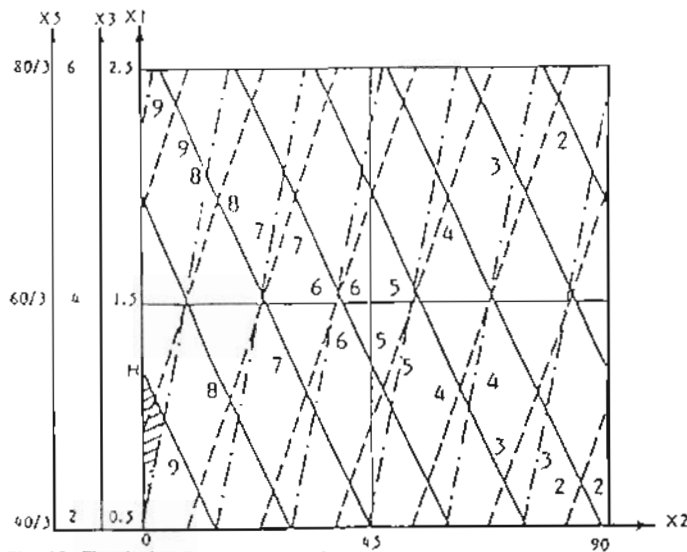

Fig. 18. The duplex cross sections of seam extension for single-thread chain stitch

- Cross section of $(X_2 - X_1)$ at $X_3 = 0, X_5 = 0$
- - - - - Cross section of $(X_2 - X_1)$ at $X_1 = 0, X_5 = 0$
- Cross section of $(X_2 - X_5)$ at $X_1 = 0, X_3 = 0$

5- CONCLUSIONS

From the work described in this paper the following conclusions have been deduced:

The optimum sewing conditions for giving the highest seam strength of woven fabrics are:

(a) When using double lock stitch:

- The distance between seam line and fabric edge is about 2 cm.
- Seam direction is as possible parallel to warp yarns.
- Number of stitches/cm is nearly 5.
- The linear density of sewing thread is about 70/3 Ne.

(b) When using single-thread chain stitch:

- The distance between seam line and fabric edge is about 1 cm.
- Seam direction is parallel to warp yarns.
- Number of stitches/cm is about 3.
- 50/3 Ne sewing thread size.

Seam strength of woven fabrics sewn with using single-thread chain stitches is higher than that sewn with using double lock stitches. Conversely, the woven fabric sewn with double lock stitch gives the greatest seam extension compared to the fabric sewn with single-thread chain stitch.

REFERENCES

- 1- В.Ф. Шаньгина. Оценка качества соединений деталей одежды, Москва, 1981.
- 2- A.M. Sheta. Alexandria Bulletin Vol. XXVI, 1987.
- 3- Burtonwood B. and Chamberlain N.H. Clothing institute technological report No. 17, October, 1966.
- 4- Севостьянов А.Т. "Методы средств исследования технико-технологических процессов текстильно-промышленности", М.: Легкая и обувная промышленность, 1980.