

EFFECT OF BLANK HOLDING FORCE OF THE FORMABILITY AND LIMITING DRAWING RATIO FOR STEEL - PLASTIC LAMINATED SHEETS

تأثير قوة ماسك القرص على كل من قابلية التشكيل ونسبة السحب لألواح الصلب المعامد للاهتزازات

M. SAMUEL

Industrial production Engg - Dept., Faculty of Engg.,

Mansoura University - Mansoura, Egypt.

خلاصة:

المعادن الحديثة والتي تستخدم في المعامد الاهتزازات والتي تعرف باسم الساندوتش هي عبارة عن لوحين من الصلب بينهما طبقة من البلاستيك، وأثناء عملية تشكيل هذا النوع من المعادن ونظرا لاختلاف الخواص الميكانيكية بين الصلب وطبقة البلاستيك تحدث مشاكل كثيرة نتيجة لهذا الاختلاف وأيضاً وجد ان العامل الهام والأساسي لمشاكل تشكيل هذه المعادن هي قوة الألتصاق بين طبقة البلاستيك ولوحين الصلب فإذا كانت هذه القوة كبيرة بدرجة كافية فهي تحسن من قابلية تشكيل هذه المعادن. أيضاً تم بحث تأثير قوة ماسك القرص على قيمة نسبة السحب أثناء عملية السحب العميق فوجد ان هذه القوة تأثير مباشر على قيمة نسبة السحب فهي ترفع من قيمته إذا تم التحكم في هذه القوة نظراً لأن قوة ماسك القرص ليست ثابتة بل متغيرة أثناء عملية السحب وكذلك حسب نوع المعدن المراد سحبه. تم اجراء التحارب في هذا البحث على ثلاث أنواع من المعادن هي الصلب/بوليستر/صلب، صلب/بولوبارين/صلب، وصلب/نايلون/صلب بسمك كلي 1.05 ملم.

Abstract

In a steel / plastic laminated sheet with a core resin as an intermediate layer. shear deformation is concentrated on the resin layer during the forming in which a shearing force appears due to a considerable difference in strength between the skin steel sheets and the core resin, leading to forming problems such as shear between the two skin steel sheets and wrinkling. It was found that these forming problems are greatly affected by the bonding strength, tensile strength and ductility of the core resin and that good formability is obtained with a bonding strength of 23.8 MPa. Comparing the variable blank holding force with the constant blank holding force, the drawability of steel / plastic laminated sheet of 1.05 mm thick - is improved when using the variable BHF. Three kinds of room temperature laminated steel sheets with polyester, polypropylene, and nylon as core resin were chosen as investigated materials.

Introduction

Deep drawing of a circular blank by a flat headed punch is commonly used to rank the deep drawing property of the sheet metal. The ratio of the largest blank to cup diameter that can be drawn successfully is called the limiting drawing ratio (LDR), a measure of draw ability. Many attempts have been made to relate the LDR with the mechanical properties of the material obtained from simple tension test [1 - 10].

Theoretically the LDR of a metal can be determined from the balance between the largest drawing load and the maximum load carrying capacity of the metal in the cup wall. The failure in cup drawing usually occurs near the punch stem of the cup wall. Basically two failure criteria have been employed to model the failure - One is based on the instability under uniaxial tension [1-4], and the other on the instability under plane - strain condition [3 - 7, 9, 10]. Early works of Siebel and Pomp [11] and Sachs [12, 13] laid the foundation for the later theoretical treatment on cup drawing process. Their elementary mechanics was largely extended by Chung and Swift [14]. But all these methods were applied to mono - metals.

Since 1980's, steel - resin - steel laminated damping sheet is one of modern materials for the panels of automobile - Laminated steel sheets which composed of three layers with steel / plastic/steel is just like a sandwich, two sides are steel sheets and the middle is the resin (plastic). There are two typical sheets for autobody parts, that is, the vibration - damping sheet which is composed of relatively thin visco elastic resin (plastic) and steel sheets for noise reduction during driving, and the light weight - saving laminate sheet of suitable combination of the strength of steel and the lightness of resin. They are combined with materials whose mechanical properties are extremely different. The press formability, that is, deep drawability, and stretch - flange formability are poor and there are another peculiar troubles which no mono - metal has [15]. Various peculiar troubles of laminate steel sheets should be solved early. In deep drawing, there are problems that wrinkling takes place easily, limiting drawing ratio and forming limit decreases, many local necks tend to occur at the outer body part.

In the present study the mechanical properties, drawability, and formability of laminated sheets at different resins. The flange drawing is considered to occur the three dimensional stress state without neglecting the thickness stress. And it is analyzed with total strain theory, assuming that the thickness of the flange remains constant during drawing. The instability condition under plan-

strain tension proposed by Moore and Wallace[3] is used in this investigation as a criterion for cup wall failure.

Analysis of Radial Drawing

Assuming that the blank material is rigid plastic and obey the power law of strain hardening, and taking into consideration the frictional resistance of the flange by blank holding force(BHF), and the frictional resistance and bending- unbending at the punch and die profile radii in deep drawing process contribute to the blank holding force. In the present analysis the flange part and the friction at die profile radius are considered in the BHF. Calculations as in the previous investigations[3, 16-18]

Basic Equation

A circular blank of original radius (d_0) and thickness(t_0) is deep drawn by a flat headed punch through a die throat Geometry and stress in the cup drawing are shown in Fig. 1.

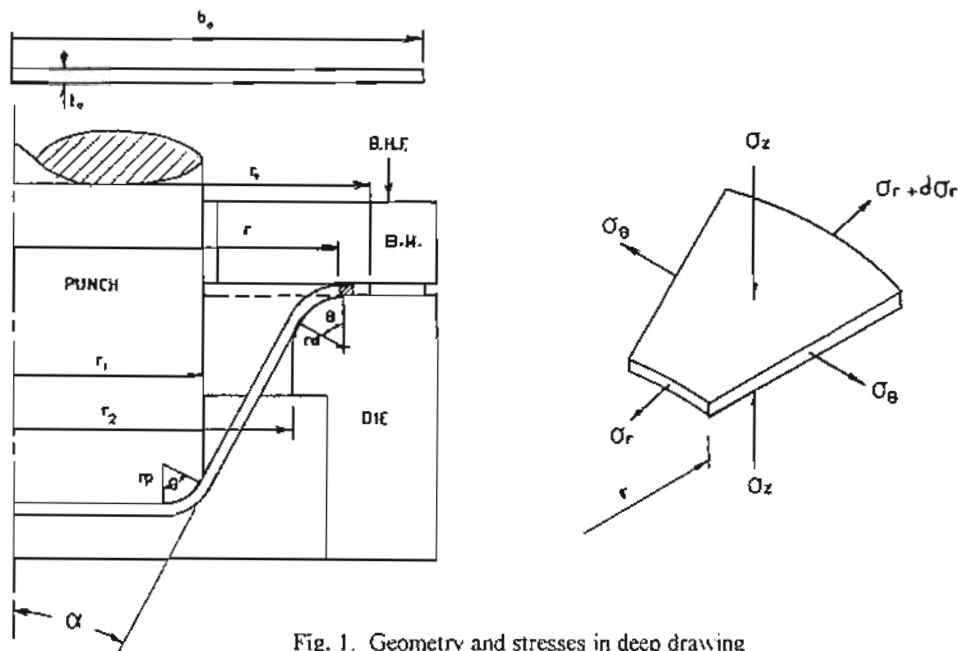

Fig. 1. Geometry and stresses in deep drawing

Assuming that the thickness remains constant during radial drawing, the flow in the flange can be characterized by plane strain deformation. The equation of radial equilibrium is

$$\frac{d\sigma_r}{dr} = \frac{\sigma_\theta - \sigma_z}{r} \quad (1)$$

and meridional stress (σ_θ) on element at die throat is given as

$$\sigma_\theta = \left(\lambda + \mu \frac{\pi}{2}\right) [\lambda \sigma_{eq} \ln(\text{CDR}) + \frac{\text{BHF} \cdot \mu \delta_d}{2\pi r_2^2 (\text{CDR})}] + \sigma_{eq} / 2\rho_d \quad (2)$$

Where

μ = friction coefficient between the blank and the die

CDR = Current drawing ratio = r/r_2

δ_d = relative die diameter = $2r_2 / t_o$

ρ_d = relative die shoulder = r_d/t_o

σ_{eq} = equivalent stress

The work hardening characteristics of the material are assumed to follow the power law:

$$\sigma_{eq} = K(\bar{\epsilon})^n \quad (3)$$

$$\sigma_{eq} = K \left[\frac{2}{3} \ln \frac{(\text{DR})^2 - (\text{CDR})^2 + [(\text{CDR} + 1)/2]^2}{[(\text{CDR} + 1)/2]^2} \right]^n \quad (4)$$

Where

DR = drawing ratio = b_o/r_1

K = strain hardening coefficient

n = strain hardening exponent

The second term of equation (2) represents the frictional resistance stress (σ_f) in flange part.

$$\sigma_f = \left(\lambda + \mu \frac{\pi}{2}\right) \left[\frac{\text{BHF}}{2r_2^2} \frac{\mu \delta_d}{(\text{CDR})} \right] \quad (5)$$

Since the maximum thickness of the flange during drawing is at the rim, the load on the blank holder is concentrated around the periphery of the flange. There is evidence to show that a finite band of contact exists around this region but it is sufficiently narrow to allow the effects of blank holding to be accommodated as a boundary stress around the periphery as follows, using equation

(2) and substituting the allowable drawing stress (σ_{a1}) and equivalent stress (σ_{eq}) into (σ_{θ}), the blank holding force (BHF) as a control variable is given by.

$$\text{BHF} = \frac{2\pi r_1^2 (\text{CDR})}{\mu \delta_d} \left[\frac{2\rho_d \sigma_{a1} - k \left[\frac{2}{3} \ln \frac{(\text{DR})^2 - (\text{CDR})^2 + [(\text{CDR} + 1)/2]^2}{[(\text{CDR} + 1)/2]^2} \right]}{2\rho_d (1 + \mu \frac{\pi}{2})} \right]^n$$

$$- (1.1) K \ln(\text{CDR}) \left[\frac{2}{3} \ln \frac{(\text{DR})^2 - (\text{CDR})^2 + [(\text{CDR} + 1)/2]^2}{[(\text{CDR} + 1)/2]^2} \right]^n \quad (6)$$

Calculation of Punch Load

From the yield criterion and associated flow rules the plane strain condition in the flange drawing becomes

$$\bar{\sigma} = (\sigma_r - \sigma_{\theta}) / m_1 \quad \text{and} \quad d\bar{\varepsilon} = m_1 d_1 \varepsilon_r \quad (7)$$

Where

$\bar{\sigma}$ = the effective stress

σ_r = the radial stress

σ_{θ} = the tangential stress

$$\text{and} \quad m_1 = \left[\frac{2^{a-1}(1+R)}{1+2^{a-1}R} \right]^{1/2} \quad (8)$$

Where

R = the anisotropic parameter

and a = Hill's criterion [19]

Using equation (7), the equilibrium equation (1), can be rewritten as

$$d\sigma_r = -m_1 \bar{\sigma} \frac{dr}{r} \quad (9)$$

Integration of equation (9) from the edge of the flange (r_0) to the radial position (r_1) gives the radial stress, $\sigma_r(r_1)$, at the junction of the flange and the cup wall. In equation (9) ($\bar{\sigma}$) is the yield stress of the material at radial position (r). It is a function of (r) and current punch travel. For convenience of the integration, the yield stress of the flange at a punch travel position is assumed to be a constant having a value of ($\bar{\sigma}$), the yield stress of the material at the die throat. The radial strain (ϵ_r) experienced by the element at the die throat is

$$\epsilon_r = \ln\left(\frac{B}{r_1}\right) \quad (10)$$

Where

$$B = \sqrt{r_1^2 + 2r_1\alpha h_1}$$

αh_1 = Current punch travel

From equations (3), (7), and (10) the yield stress at the die throat is given as

$$\bar{\sigma} = K \left[\frac{m_1}{2} \ln\left(1 + \frac{2\alpha h_1}{r_1}\right) \right]^n \quad (11)$$

Integration of equation (9) with the substitution of equation (11) for ($\bar{\sigma}$), the current radial stress at the position (r_1) becomes

$$\bar{\sigma}_r = Km_1^{n+1} \left[0.5 \ln\left(1 + \frac{2\alpha h_1}{r_1}\right) \right]^n \ln\left(\frac{r_0}{r_1}\right) \quad (12)$$

Where $r_0 = \sqrt{(b_0 - 2\alpha h_1)}$

Then the punch load required for drawing becomes

$$F_p = (2\pi r_1 t_0) Km_1^{n+1} \left[0.5 \ln\left(1 + \frac{2\alpha h_1}{r_1}\right) \right]^n * \left[0.5 \ln(DR)^2 - \frac{2\alpha h_1}{r_1} \right] e^{\mu\theta} \sin \theta$$

Where $\frac{2\alpha h_1}{r_1}$ is current drawing ratio (CDR)

$$\therefore F_p = (2\pi r_1 t_0) Km_1^{n+1} \left[0.5 \ln(1 + CDR) \right]^n * \left[0.5 \ln(DR)^2 - (CDR) \right] e^{\mu\theta} \sin \theta \quad (13)$$

Experiments

Three kinds of room temperature laminated steel sheets with polyester, polypropylene, and nylon as core resin were chosen as test materials. In addition, as a comparison, a cold rolled steel sheet was also used. The total thickness of all tested materials is 1.05 mm.

The strength of core resins is of prime importance. Therefore, a general trend was first examined using various core resins with different strength levels. A detailed examination was made by varying only elastic modules and ductility with other physical properties, of these polypropylene (P.P.) based core resins scarcely changed. The mechanical properties of the various resins used in the experiment are shown in table .1.

Table 1. Mechanical Properties of various Core Material used at R T.

Item	Strength (various cores)		
	Polyester (PE.)	Polypropylene (P P.)	Nylon (NY)
Yield strength (MPa)	1.8	13.0	12.0
U. Tensile strength (MPa)	9.0	30.0	36.0
Elongation (%)	200	240	160
Bonding strength (τ) (MPa)	4.7	23.8	18.0

The test specimen for measuring bonding strength and the relationship between bonding strength under shear and formability of laminated steel sheet is shown in Fig. 2, [20-21].

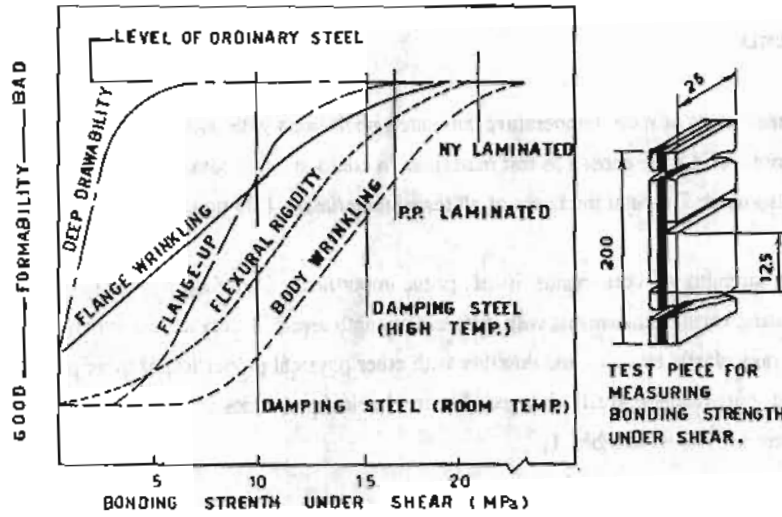
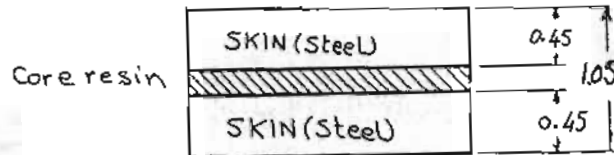

Fig.2 Relationship between bonding strength under shear and formability of laminated steel sheets [20,21]

The results of a uniaxial tension test of laminated tested materials at room temperature (RT) were shown in table 2.

Table 2. Mechanical properties of investigated materials.

Sample	Y.S (MPa)	U.T.S. (MPa)	EL %	α	r
Steel/P.P./Steel	139	259	47.7	0.250	1.59
Steel/P.E./Steel	135	252	47.1	0.246	1.58
Steel/NY/Steel	148	267	48.1	0.243	1.57
Cold rolled steel	145	262	47.5	0.252	1.55



in resin ductility, steel sheets are sensitive to plane strains, while the decrease in formability due to the deterioration in the ductility of the resin is especially remarkable on the uniaxial strain side. This is due to the horizontal strain in the resin acting in the direction of the sheet plan is very smaller, due to much lower Young's modules of the resin, than that of the steel sheets under the previously specified conditions, where the skin steel sheets meet Mohr's yield conditions.[22], with the result that effect of the deterioration in the ductility of the resin is small in the plan strain case.

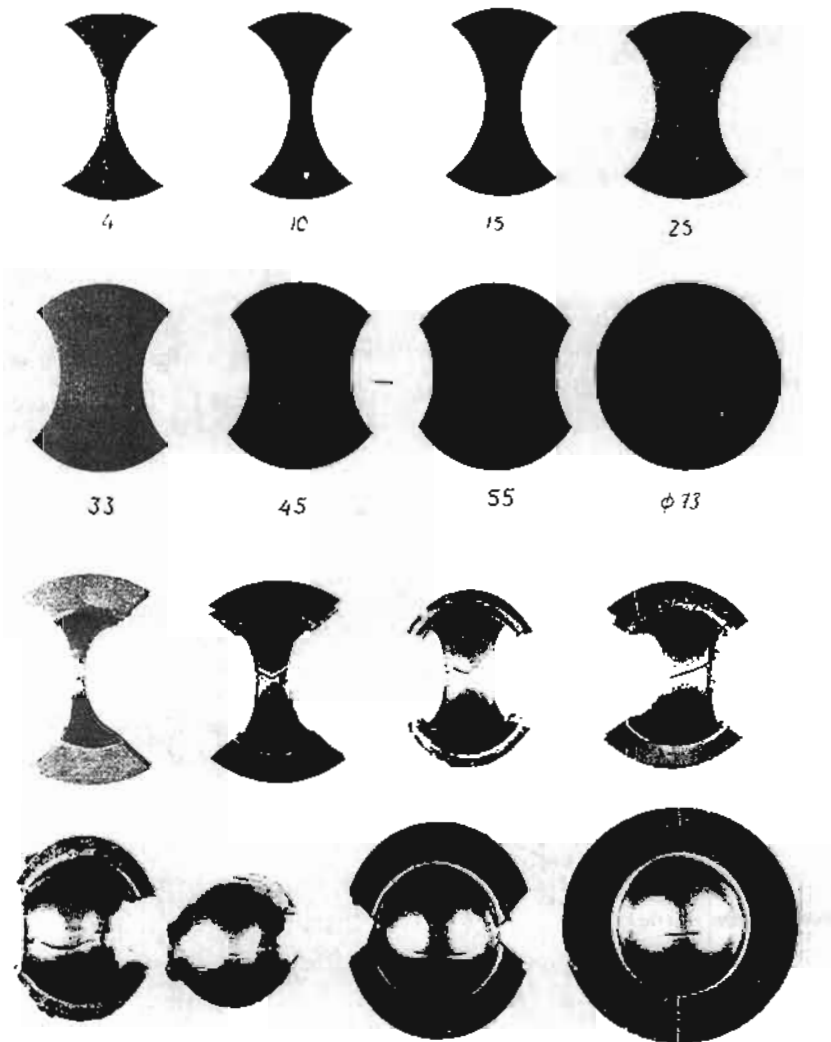

Photos. 1 and 2. The specimens before and after deformation.

The deep drawing test machine is capable of controlling ram displacements. The machine has a maximum upward speed of 120 mm/min. and a maximum capacity of 150 KN.

The used deep drawing tool is composed of a die diameter of 50 mm with a shoulder radius of 8.0 mm and a punch diameter of 46 mm with a shoulder radius of 10 mm. A specially designed wrinkle measuring instrument with an electric micrometer is used for measuring wrinkle height, where wrinkle is residual in drawn skirt.

Results and Discussion

Effects observed when core resin is different of ductility values; it was found, in the preceding section, that increasing the resin strength sufficiently is a prerequisite for ensuring good formability. However, if strength is increased too much, ductility decrease as will steel sheets and formability may be deteriorated. Therefore, the effect of changing the ductility of the core resin is investigated on the formability changes when decrease.

Ductility was decreased by adding 0% to 40 % filler to the resin, and the results are shown in Fig3. The samples before and after deformation are shown in photographs 1,2. Due to the decrease

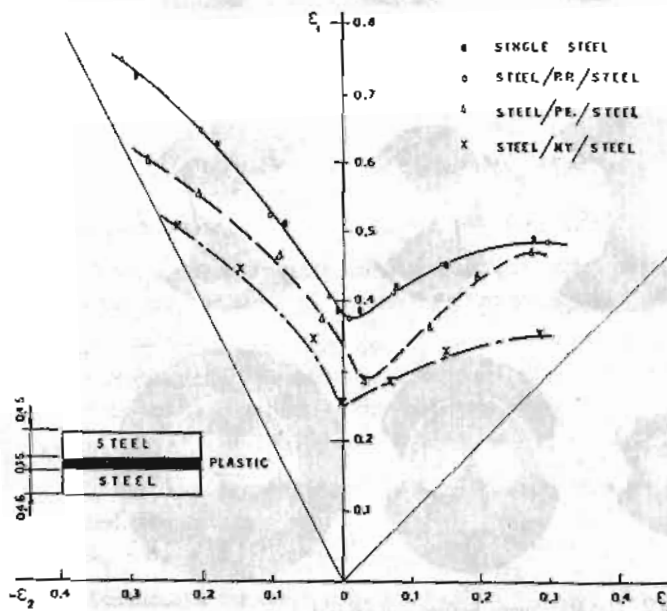

Fig.3 Effect of elongation of core resin on FLD of damping laminated steels.

On the other hand, the fracture in the resin is considered to be a controlling factor under the conditions where high tensile forces act (for example, in walls of a deep drawn part) even in the case of uniaxial, biaxial and plane strains and stresses concentration occurs in the skin steel sheets. In this case, necking occurs resulting in ruptures.

The relationship between punch load and blank holding force at different current drawing ratios;

The relationship between punch load and blank holding force at a constant value of drawing ratio ($DR=2.3$) is shown in Fig. 4. The figure, shows that the punch load, of the same current drawing ratios, increases proportionally with increasing blank holding force and then reaches the fracture load of blank material. For example, when $CDR = 1.8$ the blank holding force reaches its maximum value (57.5 KN).

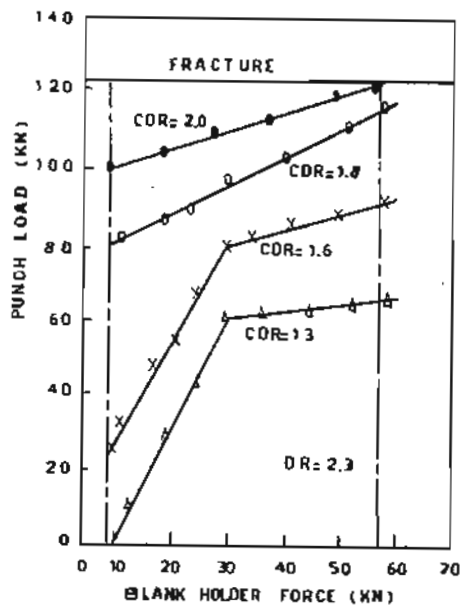

Fig. 4 The relationship between punch load and blank holding force at a constant ($DR=2.3$)

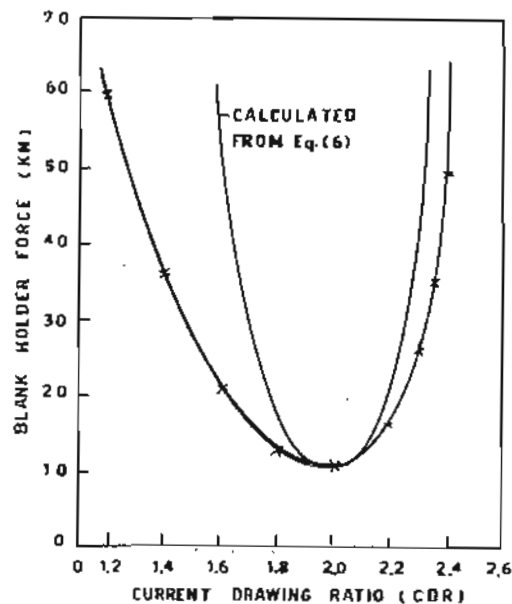

Fig. 5 The relationship between the BHF and CDR; Theoretically, experiment

In other words, this is the fracture limit of blank holding force over which fracture occurs. In the same way, the fracture limit blank holding force is obtained for each current drawing ratio (CDR) and its associated blank holding force curve is determined.

Also, it can be found that for the investigated materials, the deep drawing process succeeded in the range of blank holding force from about 9.5 KN to 30 KN. This means that the

fracture limit blank holding forces are predicted from only data in the range of these blank holding forces.

Figure 5 shows the fracture limit blank holding force curve for drawing ratio (DR=2.2). Experimental results agree sufficiently with the theoretical calculated data from equation (6). The position of minimum blank holding force when it is variable has to clearly coincide with one of the maximum punch load. Flange wrinkles height versus blank holder force are represented in Fig. (6), for a steel-resin-steel laminate and a simple steel sheet with the same thickness, indicates that the height of flange wrinkles of the laminate is larger than that of the steel sheet over all range of blank holder force. That is, the laminate requires larger blank holder force to restrain the flange wrinkles than the steel sheet. Resistance to flange wrinkling is also affected by the strength and the thickness of steel skin. In Fig. (7), blank holder force height of flange wrinkles curves are compared among two laminates having steel skins of the same thickness but of different tensile strength of steel sheet. From this figure it is obvious that reducing the tensile strength of steel skin brings clear decrease in height of flange wrinkles over all range of blank holder force. It is also noticed that experimental values of the laminate whose skin's tensile strength is 259 MPa and those of the steel sheet whose tensile strength is 262 MPa are closely plotted. In other words, the inferior resistance to flange wrinkles of the laminates can be recovered to some extent by decreasing the tensile strength of their steel skins.

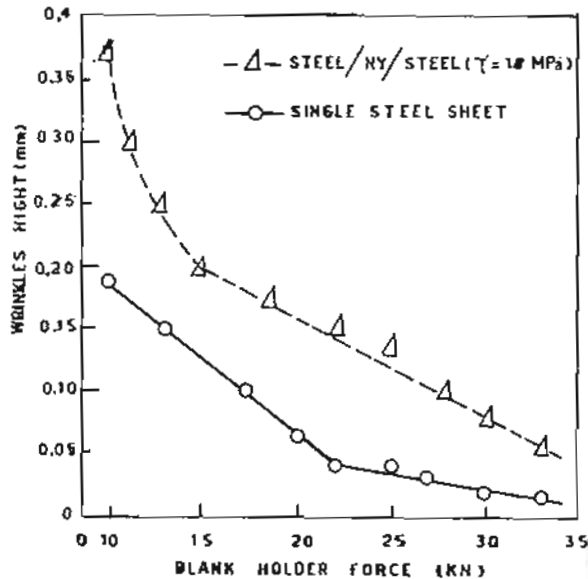

Fig. 6 Difference in height of flange wrinkles between steel laminated and single steel sheet

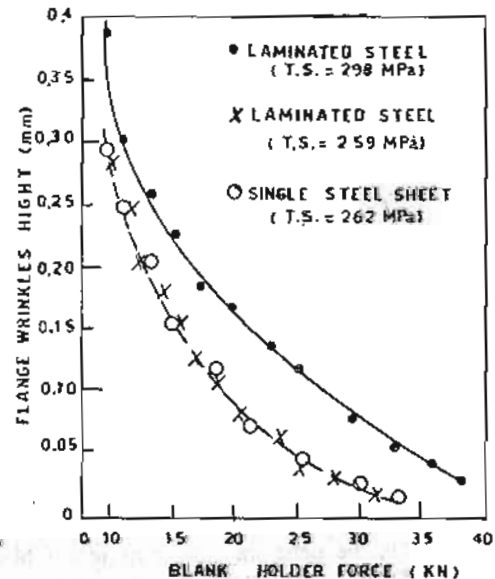

Fig. 7 Effect of tensile strength of steel skin on the BHF and height of flange wrinkles.

Fig. 8 shows a comparison of limit drawing ratios (LDR) between constant and variable blank holding force methodes. From this figure, it can be seen that the variable blank holding force is superior to limit drawing ratio (LDR) if comparison with traditional method. This is the reason that this variable blank holder force method processes effect on decreasing the wrinkle limit. Wrinkle height of this method is found to be least among the constant blank holding method from the results of comparison of wrinkle height in Fig. 9

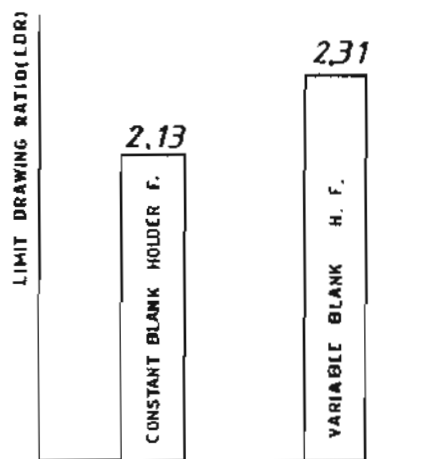

Fig. 8 Comparison of LDR between variable and constant blank holder force

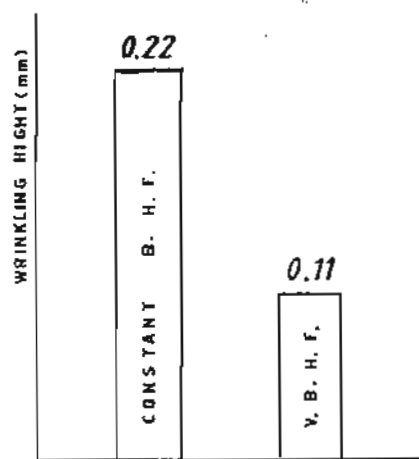

Fig. 9 Comparison of wrinkle heights between variable and constant blank holder force

CONCLUSIONS

Press formability of steel-resin-steel laminates for vibration damping has been investigated in this paper. The results was obtained as follows:

- 1- The mechanical properties of resins have a great effect on the formability of steel/plastic/steel laminated sheets. Bending strength of laminated steel sheets has strong effect on the mechanical properties and the formability's of them raising the bonding strength, the formability's of steel/plastic laminated steel sheets could be improved.
- 2- The laminates show higher flange wrinkles than steel sheets under the same blank holder force. The smaller the shear strength of resin core of the laminate, the larger blank holder force is required to restrain the flange wrinkles to an acceptable limit.

- 3- The variable blank holder force method improves the limit drawing ratio (LDR). This method is very useful for any materials of poor drawability as well as for steel/ plastic/ laminate steel sheets.

References

- 1- Barlow, D.A. : Engineering, 1956, p.p 393.
- 2- Whiteley, R.L. . Trans. ASM, Vol 52, 1960, p.p.154.
- 3- Moore, G.G. and Wallace, J.F. : J. Inst. Metals, 93, 1964, p p. 33.
- 4- Warwick, J.O. and Alexander, J.M. : J. Inst. Metals, 91, 1962, p.p.1.
- 5- Chiang, D.C. and Kobayashi, s. : J. Engng. Industry, 88, 1966, p.p. 443.
- 6- Budiansky, B. and Wang N.M. : J. Mech. Phys. solids, 14, 1966, p.p. 357.
- 7- EL-Sebaic, M G. and Mellor P.B. : Int. J. Mech. Sci., 14, 1972, p p. 535.
- 8- Hosford, W.F., Hecker, S.S , and Ghosh, A K. : Formability Analysis; Modeling and Experimentation, Metall. Soc. of AIME, N.Y., 1978. p.p. 78.
- 9- Hosford, W.F. and kim, C.; Metall Trans., 7A, 1976, 468.
- 10- Brian Fogg. : "A Fundamental Approach To Establishing A Rule Base For The Design of Tools For Pressworking" . Adv. Mater. Proc. Tech. Conf., England, Vol. 2 , 1993. p.p. 1957.
- 11- Siebel, E. and Pomp, A. . Mitt. des Kaiser wilhelms Institut Fur Eisenforschung, 11. 1929,p.p. 139
- 12- Herrmann , L. and Sachs, G.: Metallwirtschaft, 13, 1934, p.p. 705.
- 13- Sachs, G. : Proc. of the Institution of Automobile Eng., 29, 1934, p.p. 588.
- 14- Chung , S.Y. and Swift, H.W. . Proc. of the Institution of Mech. Eng., 165. 1951, p.p. 193.
- 15- Xain Cheng and lei Zhang : "Research on Forming Characteristic of Laminated Damping Sheets For Deep Drawing", IDDRG, PISA, Italy; 1991, p.p. 215.
- 16- Jun G, Lee J.W. and Yoo, D J. : Estimation of limiting Drawing Ratio in Cup Drawing", The Metall. Soc , Warrendale, Pa, U.S.A., 1992, 225.
- 17- Manabe, K. and Nishimura, H. : An Improvement in Deep Drawability of Steel/Plastic laminate sheets by control of Blank Holding Force", Adv. Tech. of Plas. Conf., Stuttgart, Germany, Vol. II, 1987, p.p. 1297.
- 18- Kawai, N. : Critecal Conditions of Wrinkling in Deep Drawing Sheet Metals" 2nd. Report, Analysis and Considerations for Conditions of Blank Holding, 26-166, 1960, p.p. 857.
- 19- Hill, R. : The Mathematical Theory of Plasticity, O.V.P., 1950, p.p. 318.
- 20- Ejima, M and Honda, T. : Tetsu To Hagane, S1621, 72, 1986.
- 21- Hashimoto, K. and Ohwue, T.: " Formability of Steel- Plastic- Laminated Sheets", IDDRG Biennial Congress, USA., 1988, p.p. 283.
- 22- Hayashi, H. : Cooperative Research on Formability of Steel- Plastic Laminate Sheets in Japan", IDDRG Congress, Pisa. Italy, 1991, p.p. 1.